



Newton's4th Ltd

PSM Comm2

Data Logging Software

User Manual

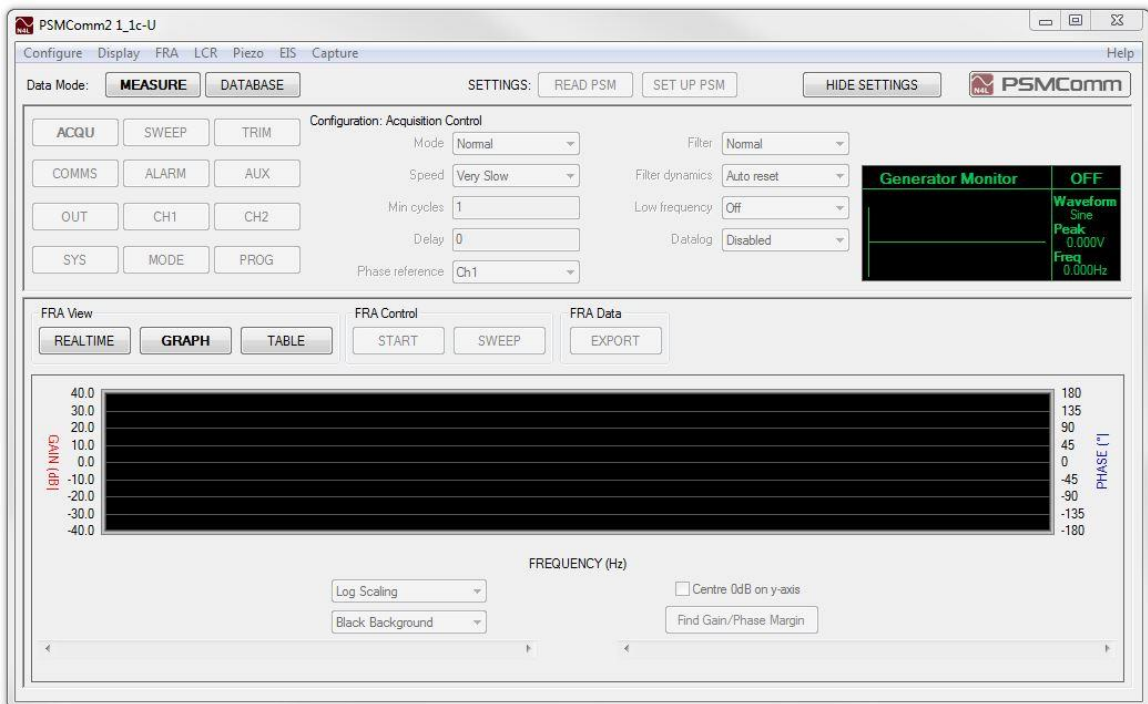

Manual constructed using Software version v1_1c

Revision 1.1

25th Sept 2018

ABOUT THIS MANUAL

PSMComm2 is a self-contained executable software program for use with the N4L PSM17xx and PSM37xx series Phase Sensitive Multimeters.

Accordingly, this manual first describes the general features and specification of the software as a whole; and then describes the individual functions in detail.

Each function is described in turn, in its own chapter, with details of the principles on which it is based, how to use it, the options available, display options etc.

Revision: 1.1

This manual is copyright © 2004-2017 Newtons4th Ltd. and all rights are reserved. No part may be copied or reproduced in any form without prior written consent.

25th Sept 2018

Table of Contents

1 Introduction	5
1.1 Introduction to PSMComm2	5
1.2 Minimum Requirements	5
2 Getting Started	6
2.1 Download.....	6
2.2 Installation.....	6
2.3 Software Settings	6
3 Connecting	9
3.1 Preparing the PSM.....	9
3.2 Connecting to your PSM.....	11
4 Configuration Panel	13
4.1 Using the Configuration Panel	13
5 The Display Menu	15
5.1 Using the Display Menu.....	15
5.2 Save to Bitmap	17
5.3 Copy to Clipboard	18
6 FRA Mode	19
6.1 Real-Time FRA Measurements	19
6.2 Performing an FRA Sweep	19
6.3 Exporting an FRA Sweep to CSV.....	22
6.4 Exporting an FRA Sweep to Excel	24
7 LCR Mode.....	25
7.1 Real-Time LCR Measurements	25
7.2 Performing an LCR Sweep	25
7.3 Graph Settings	28
7.4 Exporting LCR to CSV	33
7.5 Exporting LCR to Excel.....	34
8 Piezo Mode	35
8.1 Introduction to Piezo Mode	35
8.2 Performing a Piezo Sweep	35

PSMComm2 Software User Manual

8.3	Exporting Piezo Data to CSV	37
8.4	Exporting Piezo Data to Excel	38
8.5	Importing into Piezo mode	41
8.6	Piezo mode Calculate function	42
9	EIS Mode	43
9.1	Introduction to EIS Mode	43
9.2	Performing an EIS Sweep.....	43
9.3	Graph Settings	45
9.4	Exporting EIS Data to CSV	47
9.5	Exporting EIS Data to Excel.....	48
9.6	Importing into EIS mode.....	52
9.7	EIS mode Calculate function.....	53
10	PSMComm2 Database	54
10.1	Introduction to the PSMComm2 Database	54
10.2	Adding a Session to the database	55
10.3	Adding a Test to the Database.....	56
10.4	Removing a Test from the Database.....	58
10.5	Exporting a Database Test to CSV	59
10.6	Exporting a Database Test to Excel	62
10.7	Graphing a Database Test.....	63
10.8	Database Graph Settings	65
10.9	Finding the Gain/Phase Margins.....	69
10.10	Calculating Multiple Feedback Loop Response	70
11	Capture Mode	74
11.1	Downloading a screenshot from a PSM.	74
12	Using PSMComm2 CSV Files.....	76
12.1	Importing CSV Files into Excel	76

Appendices

Appendix A: Contact Details

1 Introduction

1.1 Introduction to PSMComm2

PSMComm2 is a self-contained executable software program written in C++ using the Microsoft win32 graphics set.

PSMComm2 has the ability to connect to the PSM series of instruments via RS232, USB, and LAN. The software includes all measurement modes to reflect instrument operation.

PSMComm2 supports the ability to export text files in CSV format as well as export directly to Microsoft Excel.

This guide was written using a PSM3750 with Firmware version V1.36

1.2 Minimum Requirements

The minimum requirements to run the PSMComm2 Software are as follows:

- Windows XP (Service Pack 3) or later
- At least 1GHz Processor
- Minimum of 1GB RAM
- 10MB of Hard Drive space.

2 Getting Started

2.1 Download

As with all N4L Software, it is available for free download from our website. See www.newtons4th.com/support for more details. Once registered and your account has been activated you will have access to the software downloads section.

2.2 Installation

Wherever possible, at N4L we try to develop software that enables the engineer to be ready and performing tests as soon as possible. With this in mind, we have made PSMComm2's installation method as simple as possible.

To install PSMComm2, simply download the .exe file onto your PC's hard drive or an external drive such as a USB memory stick and run it straight away.

2.3 Software Settings

To access the Settings window go to *Configure* and click "Settings..." from the drop-down menu

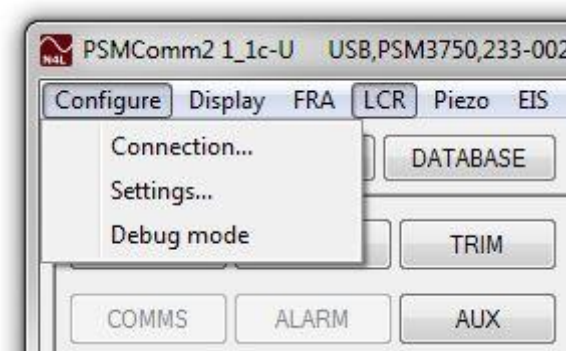

This brings up the Software Options window which allows you to change settings that affect everything in PSMComm2.

The Software Options window:

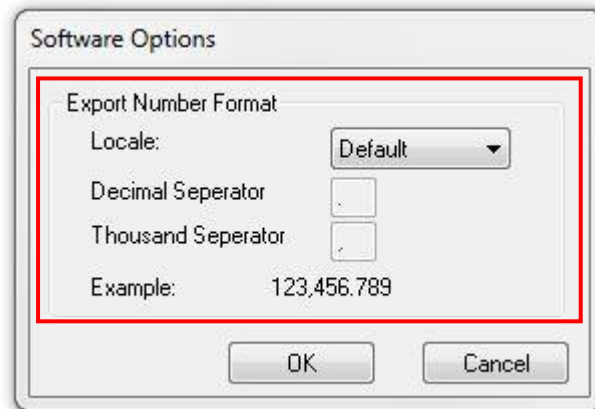

Export Number Format allows you to change the format in which PSMComm2 will export numbers to CSV and to Excel. This is initially set to "Default", which will take the number format settings for your PC's locale settings.

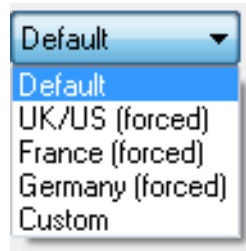

The other options are:

- UK/US (forced) which attempts to export with the UK/US number format which uses `.` as a decimal separator and `,` as a thousand separator
- France (forced) which attempts to export with the French number format which uses `,` as a decimal separator and ` ` as a thousand separator
- Germany (forced) which attempts to export with the German number format which uses `,` as a decimal separator and `.` as a thousand separator
- Custom which allows you to set your own decimal and thousand separator

For most cases, this should be left as "Default".

PSMComm2 Software User Manual

Debug Mode

PSMComm2's Debug mode can be accessed from the Configure Menu:

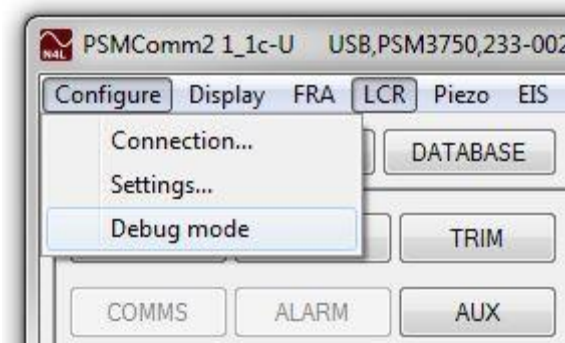

When entering Debug Mode, PSMComm2 will ask for a location to store the debug log file, select a file location and press OK to enter Debug Mode

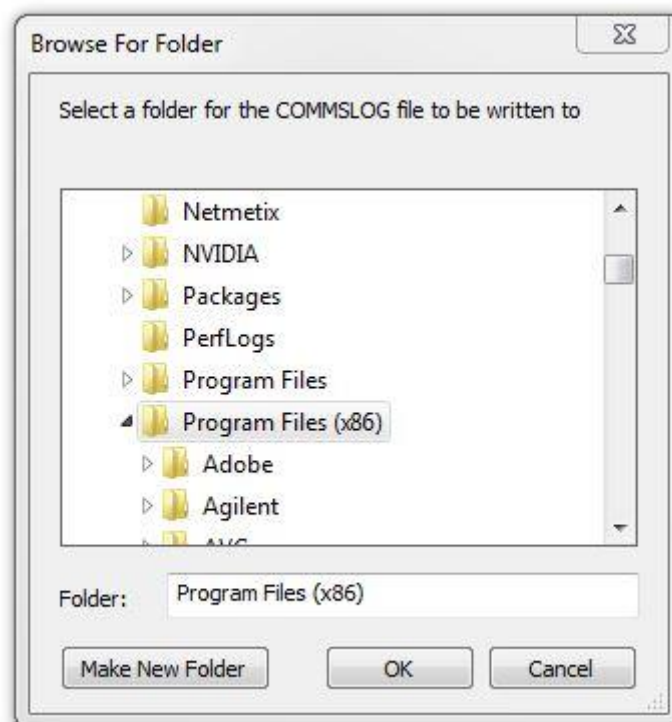

While in Debug Mode, PSMComm2 will create a log of all communication with the connected PSM in a log file.

3 Connecting

3.1 Preparing the PSM

Before the software can connect, the PSM must be ready to accept the connection. To prepare your PSM for connection with PSMComm2, ensure the unit is powered on and the cables are connected.

Next, you must ensure the Instrument is correctly set up to reflect the type of connection you are using. To do this, access the COMMS menu on the unit; navigate to the Interface option and select the interface you are using to connect to the software: RS232, USB, or LAN.

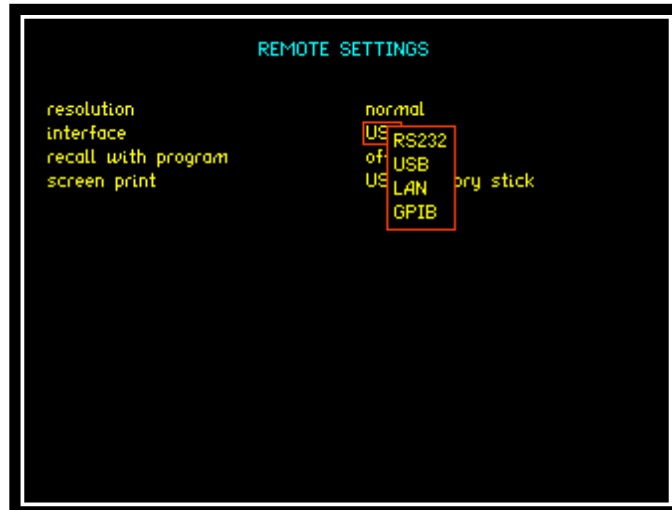

If you select RS232, you will need to additionally set the Baud Rate of the cable you intend to use

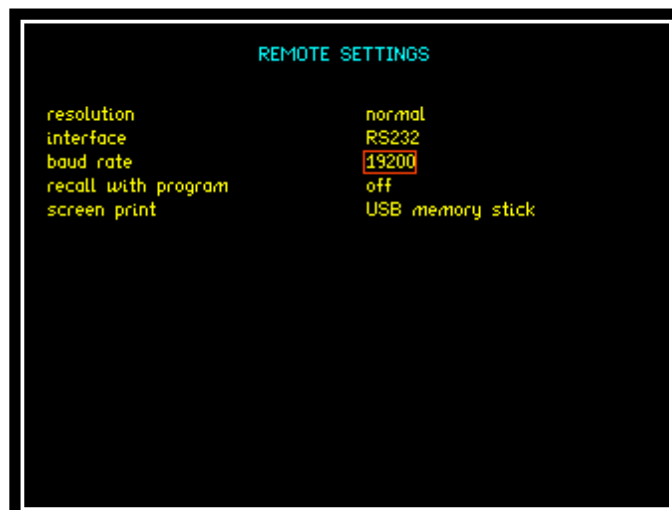

PSMComm2 Software User Manual

For LAN you'll need to set an IP Address for the Instrument.

```
REMOTE SETTINGS
resolution          normal
interface           LAN
IP address          192.168.0 .125
recall with program off
screen print        USB memory stick
```

Please note that the GPIB option is for connecting the PSM to other equipment, and not for communicating with PSMComm2.

3.2 Connecting to your PSM

To begin connecting to an instrument, click on *Configure* and select “*Connection...*” from the drop-down menu.

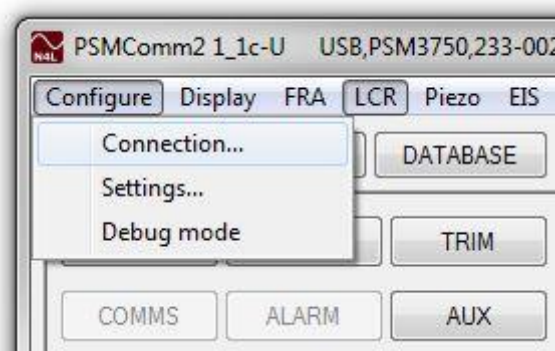

This brings up the communications window where you'll set up how you're connecting to the instrument.

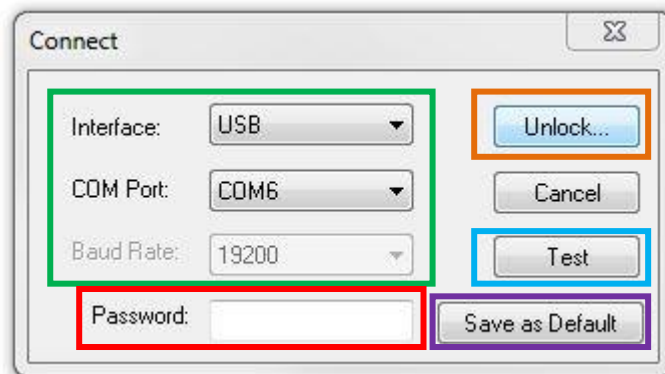

Enter the PSM's **communication details** by selecting the communication method (Serial, USB or LAN).

If you selected *LAN* you'll need to enter the same IP as you set your unit to.

If you selected *USB* or *Serial* you'll need to select the COM port that windows assigned to your cable. Additionally, if you select *Serial* you'll need to set your cable's Baud Rate.

To check the connection settings are correct, press the **Test button** to attempt a connection. This will then bring up a message telling you if the connection was successful.

PSMComm2 Software User Manual

If you failed to connect, it will bring up a message telling you the connection failed



If the connection was successful, the message will tell you the details of the instrument you are connected to, such as its model, serial number, and firmware level.

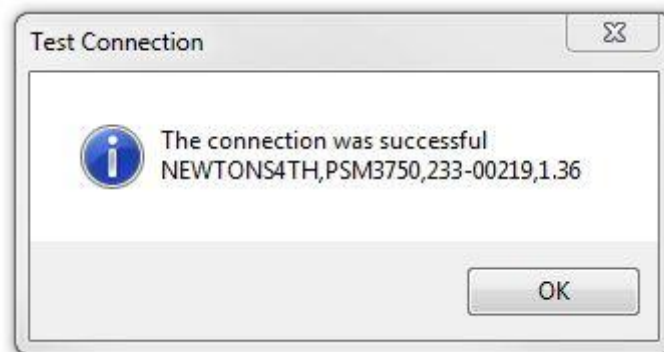

If you want PSMComm2 to remember your current connection settings and reload every time you open the connection window, you can do so by pressing the **Save as Default** button.

If this is the first time you've used PSMComm2, you will need to enter an **Unlock Code**, if you haven't received an Unlock Code contact your local Newtons4th Distributor or our support team.

Once you press **Connect** (or **Unlock**) the software will then connect to and download the Configuration settings for each instrument it is able to connect to.

4 Configuration Panel

4.1 Using the Configuration Panel

The connected instrument's settings are stored in the configuration panel and can be edited and sent back to the instrument.

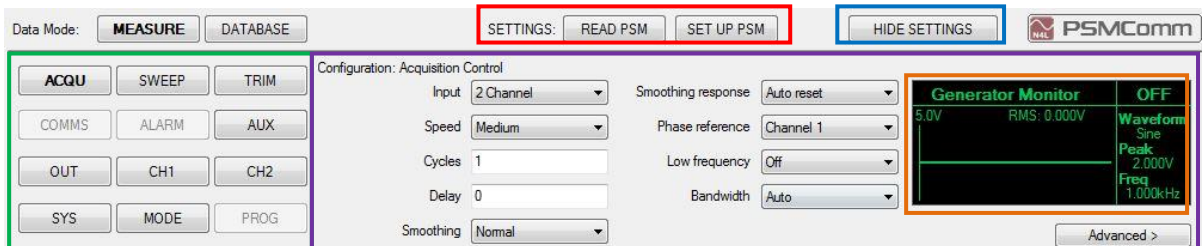

Before changing any settings in the Control Panel you should always press **READ PSM** this enables the software to download that PSM's settings to ensure the software is configured with any changes that have been made to the PSM's settings on the instrument's front panel.

Then choose which **settings menu** to look at and edit, the individual instruments settings can be modified in the **Configuration Control Panel**.

The **Generator Monitor** can be found in the **Configuration Control Panel**. This displays the PSM generator waveform settings and status. It is constantly updated to indicate if the generator output is ON or OFF. The display changes to reflect the waveform selected from the dropdown in the **output** menu.

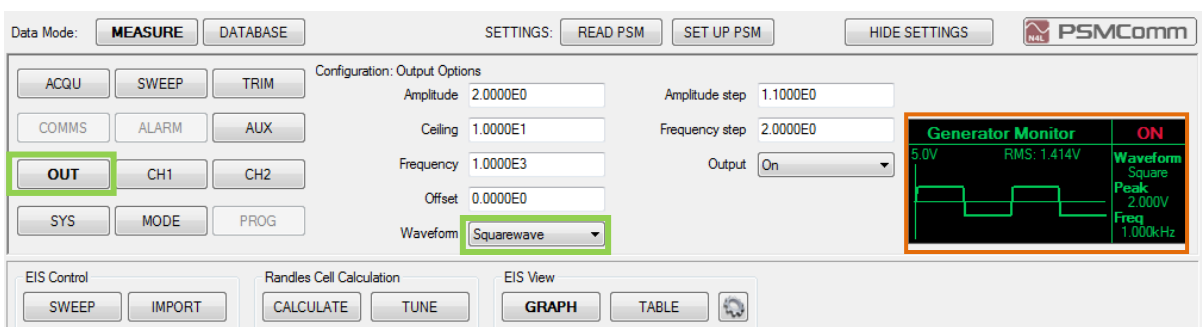

The waveforms available are dependent on the PSM model connected to the software.

The menus in PSMComm2 are designed to mimic the Instrument's settings panels. For more information on what each setting does, check the respective Instrument's User Manual.

Finally, the changes you made need to be communicated to the Instrument; any amended settings are sent by pressing the **SETUP PSM** button. **The changes must be sent to the instrument for the instrument to be configured correctly.**

Additionally, you can hide and show the Configuration Panel by pressing the **Hide Settings** and **Show Settings** button.

5 The Display Menu

5.1 Using the Display Menu

The Display menu is used to save the displayed screen as a picture.

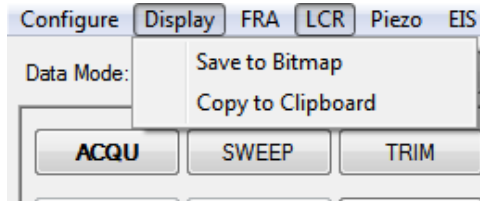

The following are examples of screens that can be saved:

FRA's Real Time display

Frequency	Magnitude 1	Magnitude 2	Gain 1
10.000 Hz	550.00 nV	1.3265 uV	7.647dB
Phase 1	Delay 1	Magnitude 3	Gain 2
-101.72°	28.256 ms	1.6770 uV	9.6835 dB
Phase 2	Delay 2		
-114.45°	31.791 ms		

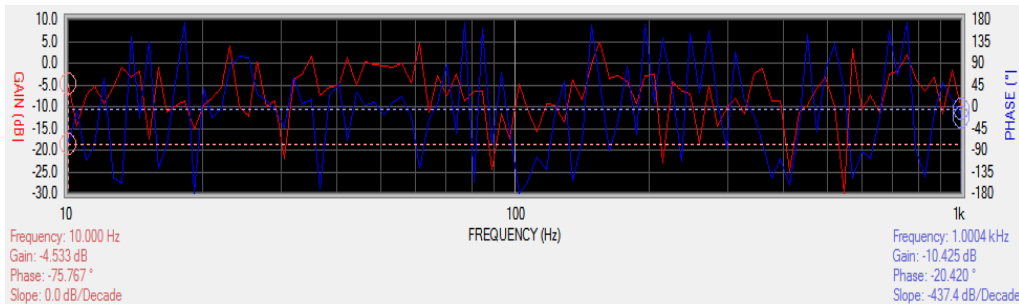

FRA's Graph

LCR's Real Time display

PSMComm2 Software User Manual

Frequency	Magnitude 1	Magnitude 2	Impedance	Phase
10.000 Hz	656.61 nV	2.4954 uA	263.13 m Ω	159.40 °
Series R	Series L	Series C	Parallel R	Parallel L
-246.31 m Ω	1.4732 mH	-171.94 mF	-281.09 m Ω	11.905 mH
Parallel C	Tan δ	Q	Reactance	
-21.278 mF	2.6610	375.80 m	92.562 m Ω	

LCR's Bode graph

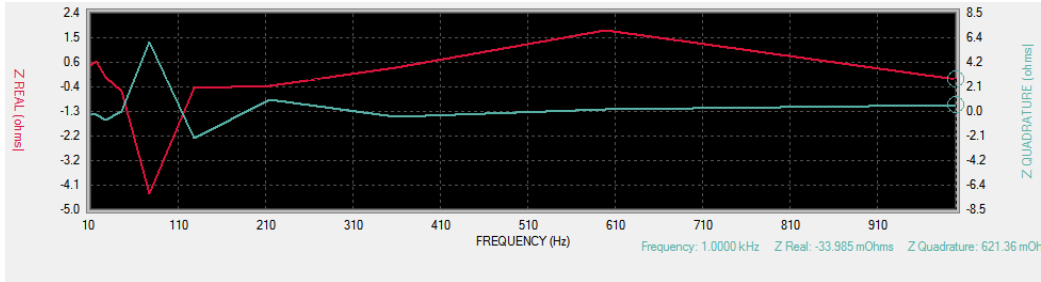

LCR and

EIS's Nyquist Graph

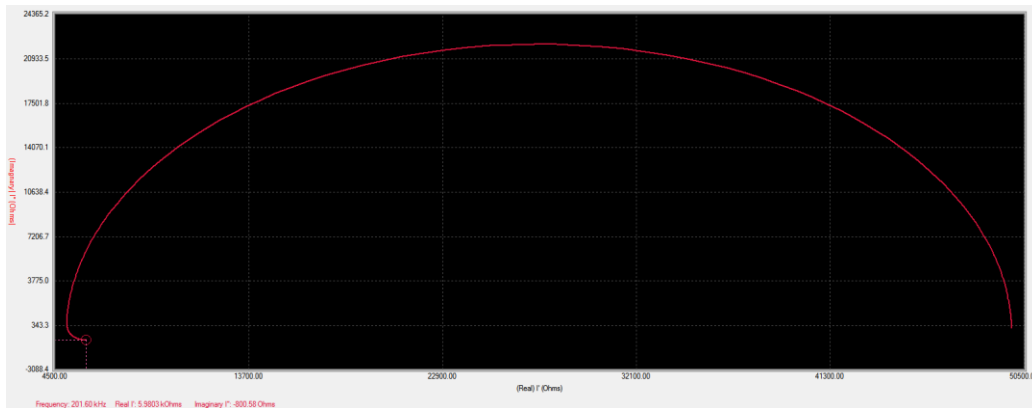

Piezo's Graph

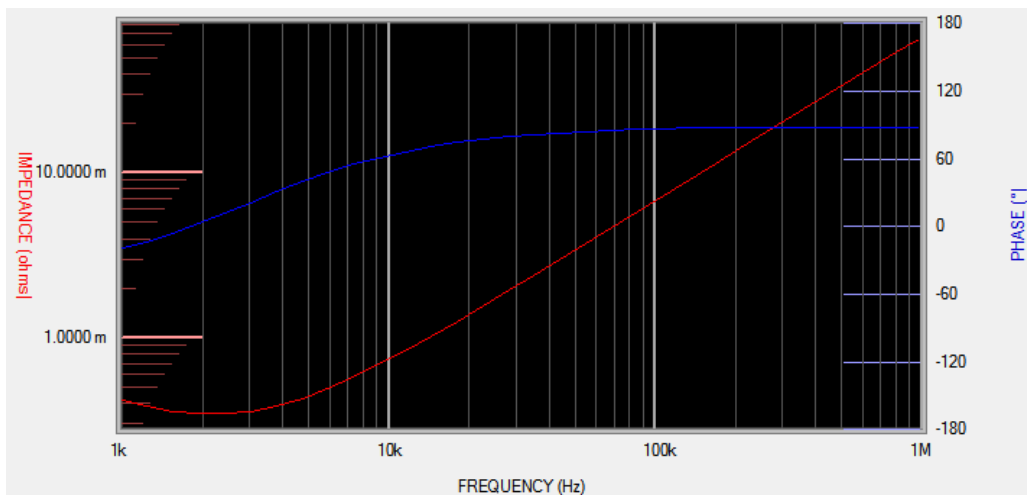

Capture Mode's Screenshot

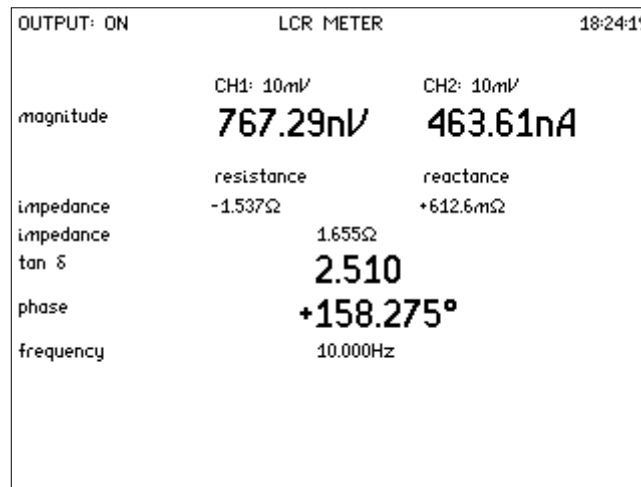

5.2 Save to Bitmap

Save to Bitmap allows you to save the current screen as a .bmp image.

After the Save to Bitmap menu item has been clicked, PSMComm2 will need a file location to save the image to.

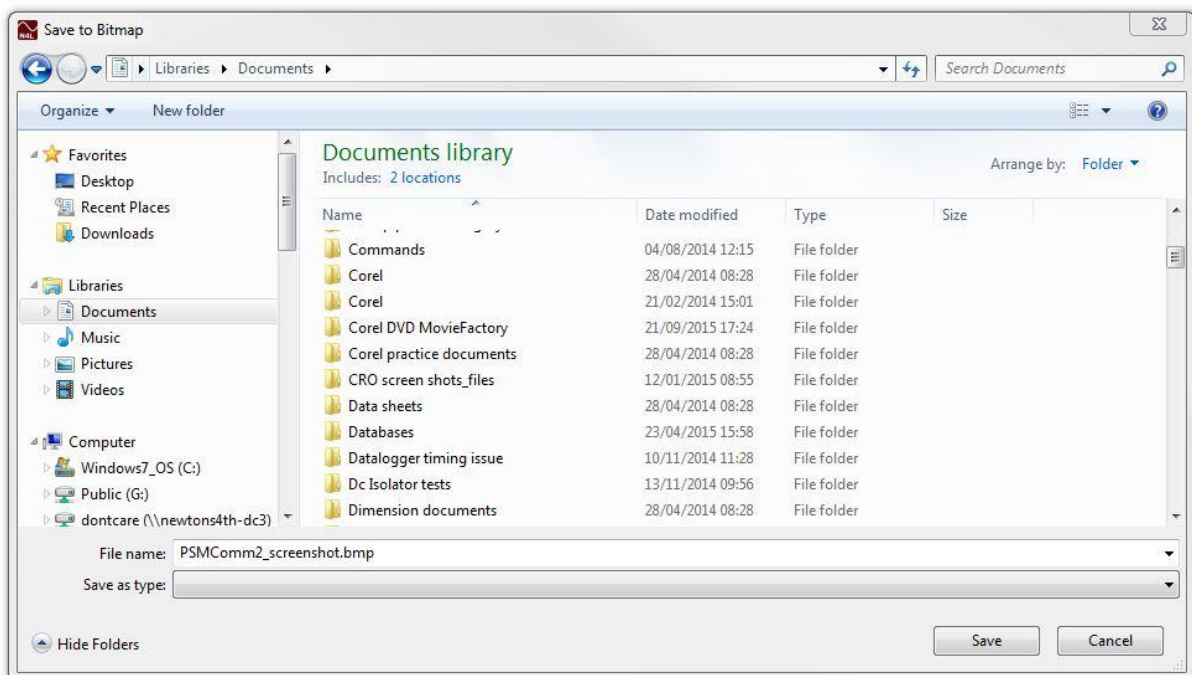

*Note: to save your .bmp file, remove the * and replace with your file name before clicking on save*

Once a location has been selected, press the Save button to save the screenshot.

5.3 Copy to Clipboard

Copy to clipboard saves the image in your windows clipboard. The screenshot can then be pasted anywhere that you'd normally use an image such as an Email, a Picture Editor (eg. MS Paint, Microsoft Word, Microsoft Excel, etc.)

6 FRA Mode

6.1 Real-Time FRA Measurements

To see the real-time data gathered by the PSM, ensure you're in FRA Mode by pressing the FRA button at the top of PSMComm2.



PSMComm2 will reload all the settings from the connected PSM.

To read in data from the PSM in real-time, change the view mode to **REALTIME**

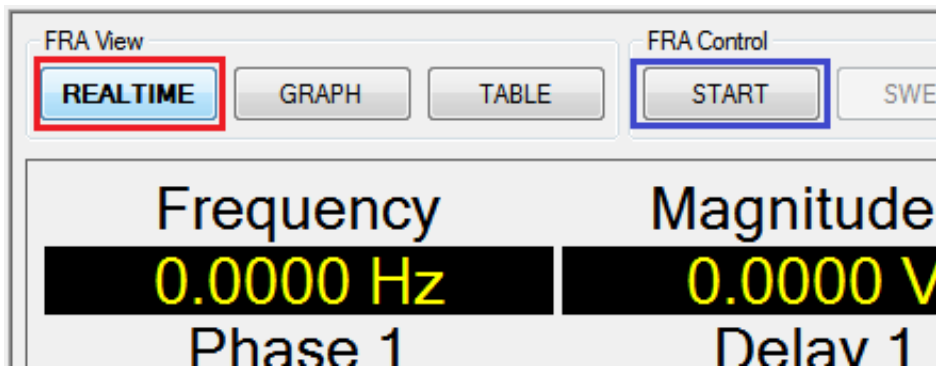

And press **START** to begin logging and PSMComm2's data display will update with the latest values from the connected PSM.

6.2 Performing an FRA Sweep

Frequency	Magnitude 1	Magnitude 2	Gain 1
10.000 Hz	354.31 nV	510.12 nV	3.166dB
Phase 1	Delay 1	Magnitude 3	Gain 2
-67.195°	18.665 ms	804.33 nV	7.1211 dB
Phase 2	Delay 2		
-20.715°	5.7540 ms		

PSMComm2 Software User Manual

To perform an FRA sweep, ensure you're in FRA Mode by pressing the FRA button at the top of PSMComm2



PSMComm2 will reload all the settings from the connected PSM.

To start a sweep, change the view mode to **GRAPH** or **TABLE**

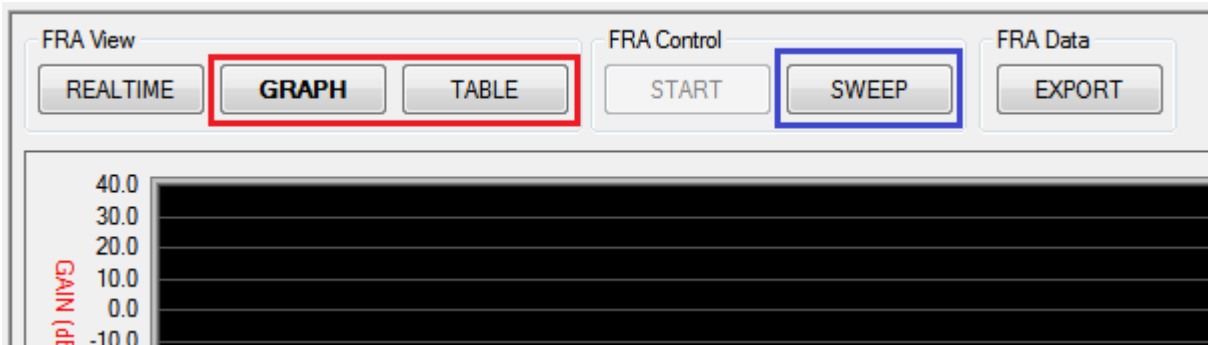

And press **SWEEP** button to bring up the Test Details window which allows you to set up an FRA sweep.

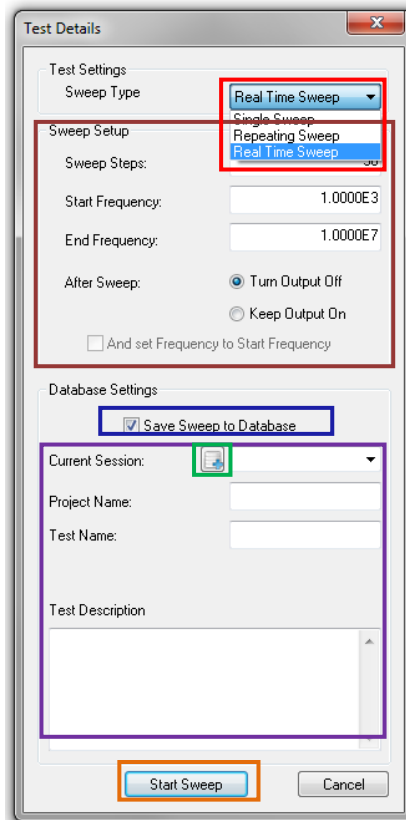

You can select to perform a **Single Test**, **Repeating Test** or a **Real Time Sweep**.

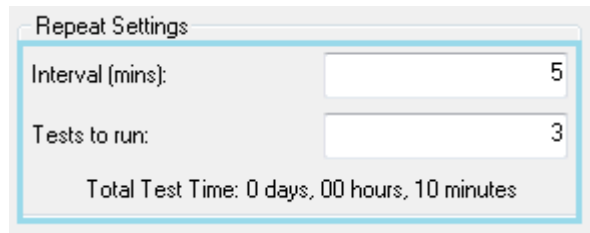

The 'Repeat Settings' dialog box contains the following fields and values:

Field	Value
Interval (mins):	5
Tests to run:	3
Total Test Time: 0 days, 00 hours, 10 minutes	

Selecting a **Repeating Test** brings up some additional options where you can set the number of **Tests to run** and the **Interval** between sweeps starting.

The **Real-Time Sweep** option builds up the graphical display point by point or populates the table as the sweep progresses.

The **Sweep Setup** details can be checked and updated if necessary.

FRA Sweeps can be **Saved to the Database**; to save a sweep to the Database it will need a **Current Session**, **Project Name**, **Test Name** and (optionally) a **Test Description**. You can start a new session by pressing the **Add Session Button** which will bring up this window

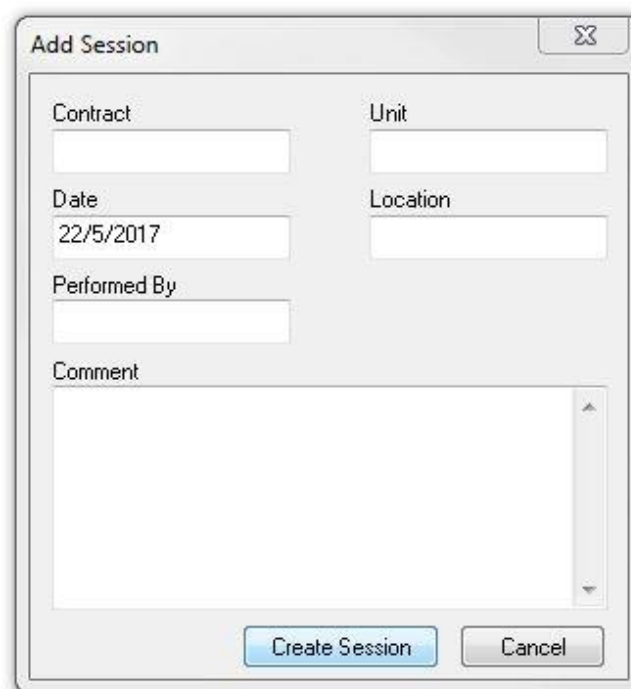

The 'Add Session' dialog box contains the following fields and values:

Field	Value
Contract	
Unit	
Date	22/5/2017
Location	
Performed By	
Comment	

Buttons: Create Session, Cancel

Enter the session details and press the Create Session button to save the sessions to the database.

Once the sweep has been set up, press the **Start Sweep** button and PSMComm2 will start to get the connected PSM to sweep.

6.3 Exporting an FRA Sweep to CSV

To export to CSV, once the sweep is completed press the **Export** button.

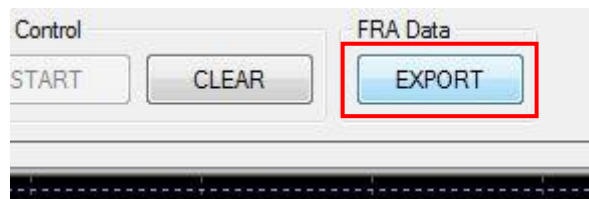

And select **Export to CSV**

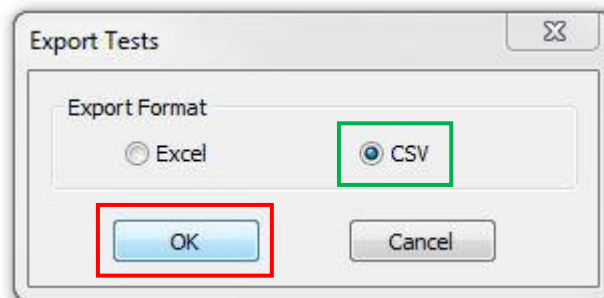

Press **OK** and PSMComm2 will ask for a file location:

PSMComm2 Software User Manual

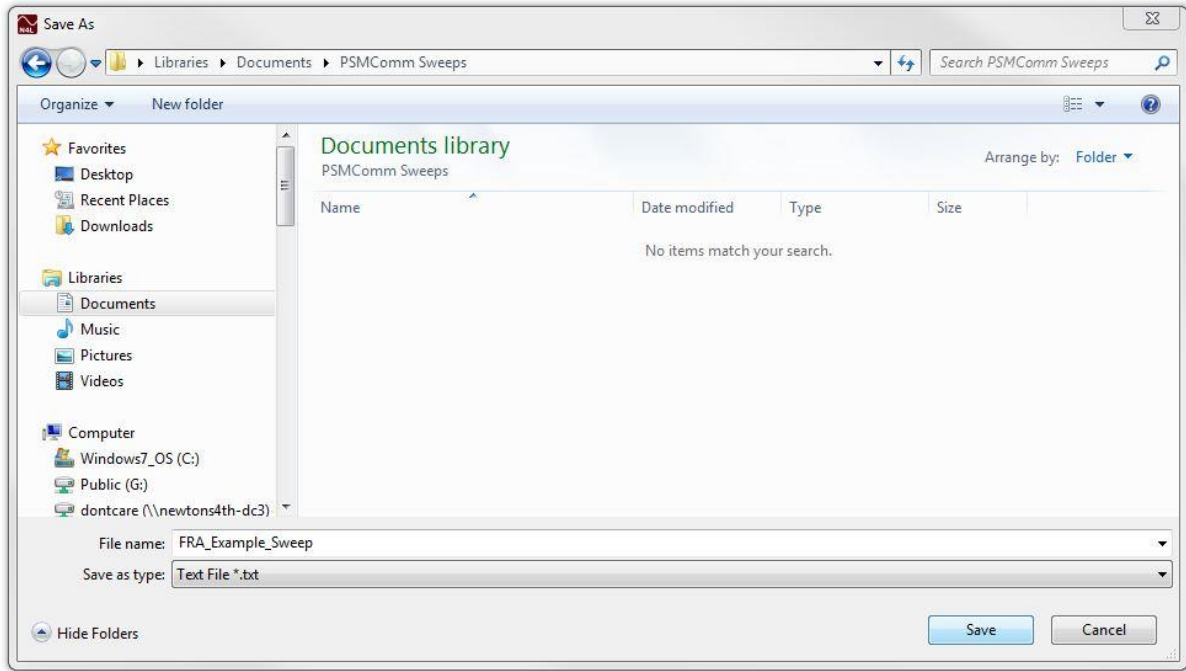

Select a file location for the data to be stored in and set a file name; finally, press Save.

6.4 Exporting an FRA Sweep to Excel

To export to Excel, once the sweep is completed press the **Export** button.

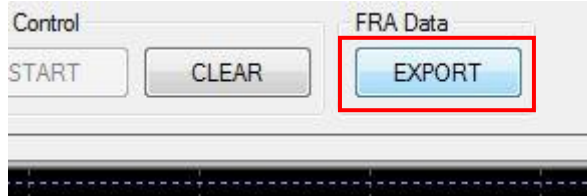

Select **Export to Excel** is selected and press **OK**.

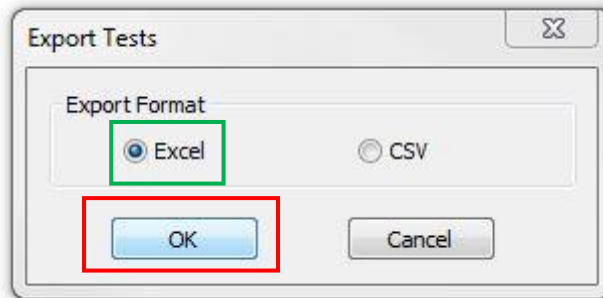

Excel will open with the step count and all the FRA data from the sweep. Excel can be used to save the data to a ".xlsx" file.

	A	B	C	D	E	F	G
1	PSMComm2 v1_1c					22nd May 2017 - 10:24:11	
2	N4L PSMComm2 FRA Sweep Data 1/1						
3	Steps	Frequency	Magnitude 1	Magnitude 2	Gain 1	Phase 1	Delay 1
4	1	1.00E+00	7.12E-02	1.57E-03	-3.31E+01	-1.36E+01	3.78E-02
5	2	5.15E+01	5.95E-02	1.51E-03	-3.19E+01	6.43E+00	1.91E-02
6	3	1.02E+02	7.47E-02	1.61E-03	-3.33E+01	7.40E-02	9.80E-03
7	4	1.52E+02	7.66E-02	1.54E-03	-3.39E+01	5.60E+00	6.46E-03
8	5	2.03E+02	7.14E-02	1.63E-03	-3.28E+01	8.99E+00	4.80E-03
9	6	2.53E+02	6.93E-02	1.67E-03	-3.24E+01	8.97E+00	3.85E-03
10	7	3.04E+02	7.85E-02	1.62E-03	-3.37E+01	1.34E+01	3.17E-03
11	8	3.54E+02	7.57E-02	1.60E-03	-3.35E+01	1.08E+01	2.74E-03
12	9	4.05E+02	6.90E-02	1.58E-03	-3.28E+01	1.74E+01	2.35E-03
13	10	4.55E+02	7.02E-02	1.60E-03	-3.28E+01	1.80E+01	2.09E-03
14	11	5.06E+02	7.28E-02	1.71E-03	-3.26E+01	2.28E+01	1.85E-03
15	12	5.56E+02	7.07E-02	1.65E-03	-3.26E+01	2.50E+01	1.67E-03
16	13	6.07E+02	7.25E-02	1.71E-03	-3.26E+01	3.05E+01	1.51E-03
17	14	6.57E+02	5.87E-02	1.65E-03	-3.10E+01	2.37E+01	1.42E-03
18	15	7.08E+02	6.25E-02	1.68E-03	-3.14E+01	3.39E+01	1.28E-03
19	16	7.58E+02	5.95E-02	1.76E-03	-3.06E+01	2.17E+01	1.24E-03
20	17	8.09E+02	5.11E-02	1.80E-03	-2.91E+01	2.70E+01	1.14E-03
21	18	8.59E+02	5.25E-02	1.79E-03	-2.94E+01	2.74E+01	1.07E-03
22	19	9.10E+02	5.33E-02	1.68E-03	-3.00E+01	2.13E+01	1.03E-03
23	20	9.60E+02	4.62E-02	1.67E-03	-2.88E+01	1.16E+01	1.01E-03
24	21	1.01E+03	4.56E-02	1.68E-03	-2.87E+01	2.02E+01	9.34E-04
25	22	1.06E+03	5.07E-02	1.60E-03	-3.00E+01	9.87E-01	9.40E-04

7 LCR Mode

7.1 Real-Time LCR Measurements

To see the real-time data gathered by the PSM, ensure you're in LCR Mode by pressing the **LCR** button at the top of PSMComm2.

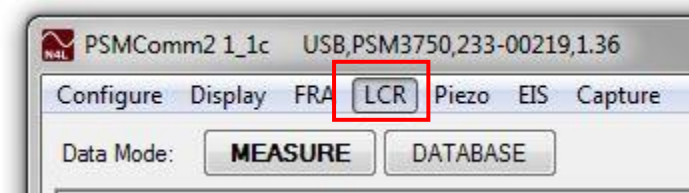

PSMComm2 will reload all the settings from the connected PSM.

To read in data from the PSM in real-time, change the view mode to **REALTIME**



And press **START** to begin logging and PSMComm2's data display will update with the latest values from the connected PSM

Frequency	Magnitude 1	Magnitude 2	Impedance	Phase
10.000 Hz	428.41 nV	777.11 nA	551.28 m Ω	12.942 °
Series R	Series L	Series C	Parallel R	Parallel L
537.28 m Ω	1.9650 mH	-128.91 mF	565.65 m Ω	39.177 mH
Parallel C	Tan δ	Q	Reactance	
-6.4657 mF	4.3517	229.80 m	123.46 m Ω	

7.2 Performing an LCR Sweep

PSMComm2 Software User Manual

To perform an LCR sweep, ensure you're in LCR Mode by pressing the **LCR** button at the top of PSMComm2

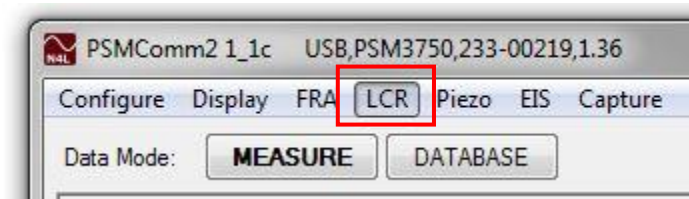

PSMComm2 will reload all the settings from the connected PSM.

To start a sweep change the View mode to **BODE**, **NYQUIST** or **TABLE**

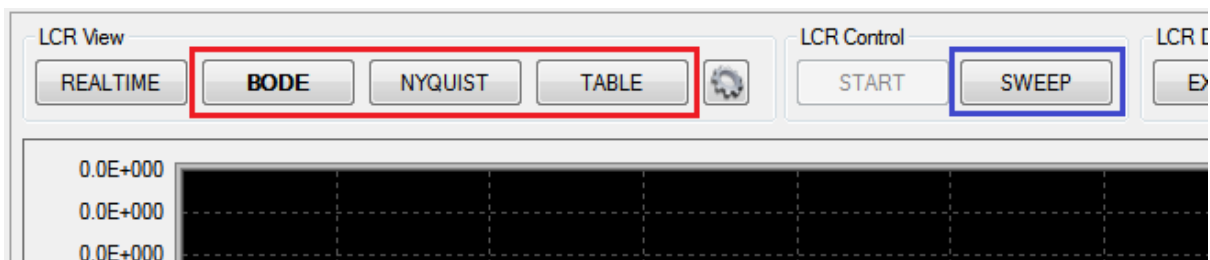

And press **SWEEP** button to bring up the Test Details window which allows you to set up an FRA sweep.

You can select to perform a **Single Test**, **Repeating Test** or a **Real Time Sweep**.

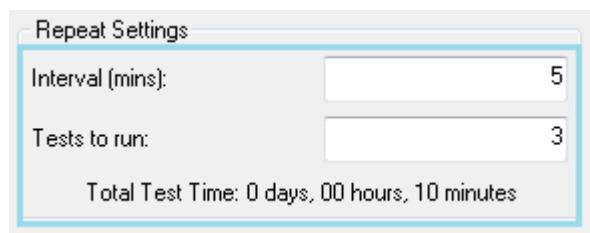

Selecting a **Repeating Test** brings up some additional options where you can set the number of **Tests to run** and the **Interval** between sweeps starting.

The **Real-Time Sweep** option builds up the graphical display point by point or populates the table as the sweep progresses.

The **Sweep Setup** details can be checked and updated if necessary.

PSMComm2 Software User Manual

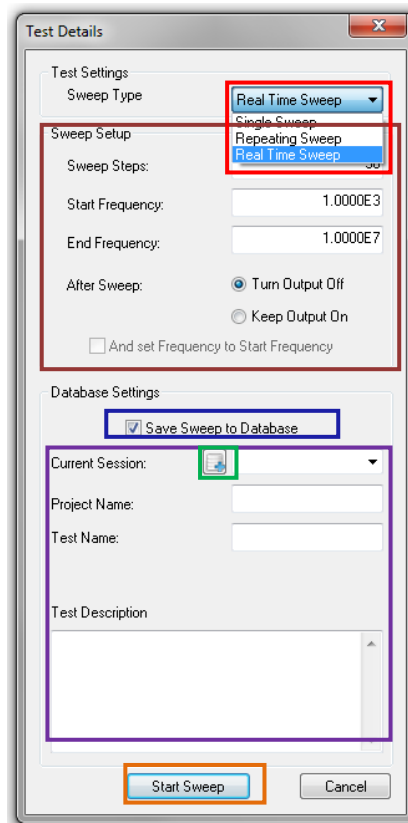

7.3 Graph Settings

To change the visual settings of LCR Graphs, press the **Graph Settings** button while the View Mode is either Bode or Nyquist.

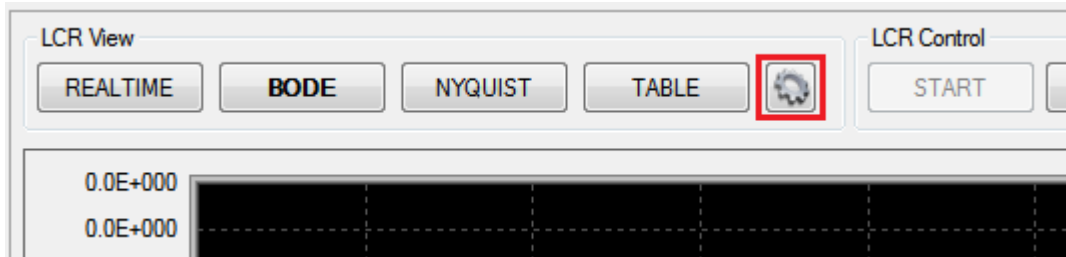

Both Bode and Nyquist have their own settings that can be edited separately

This brings up the Graph Settings window. Selecting one of the Settings View options updates the settings displayed in the Graph Settings window. Selecting Plot A or Plot B displays the following settings:

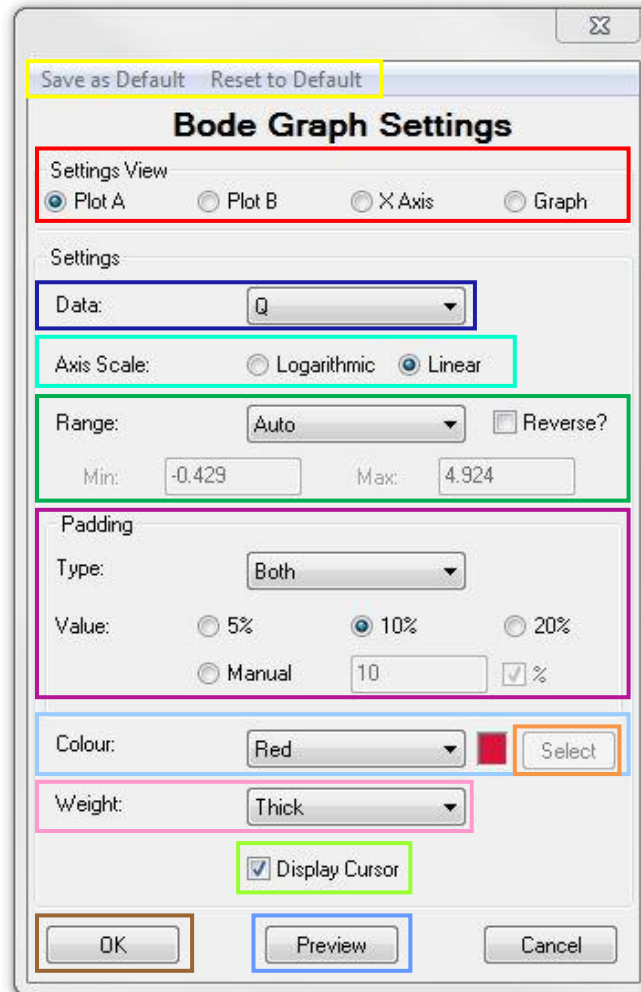

All the options in the graph settings window are available by right-clicking the graph. The Graph Settings window allows you to choose the style of Y-Axis Plots, the X-Axis, and the general Graph style, Plot A controls the left Y-Axis and Plot B controls the right Y-Axis.

Data allows you to select which data the plot will graph. The actual options included in the drop-down menu depend on the PSM model being used and the instrument settings.

Axis Scale allows you to edit the scale of the Y-axis; there is the choice between Linear and Logarithmic. When a Logarithmic scale is selected the scaling on the graph in the software window for the left Y-axis can be different to that of the right Y-axis.

Range will allow you to change the Range of both left and right Y-Axis as well as the X-Axis, while Padding allows you to change how much relief there is between the plot and the edge of the graph in both X and Y directions.

For additional customisation, you can change the **colour** (including **selecting a custom colour**) and **weight** of both of the Y plots as well as being able to turn the **plot cursors** on and off for both Y plots.

Preview allows you to view the changes on the LCR Graph, and once you're happy you can either save it as a **new default**, **reload the current default**, press **OK** or cancel to leave the graph as it was.

Note: These settings are **ONLY** for the graph displayed in the software. The instrument settings **MUST** be adjusted in the Configuration menus in the software or on the instrument and the **READ PSM** or **SETUP PSM** buttons in the software used to ensure the instrument and software are both using the same settings. Further details can be found in Section 4.

Bode Plot **X-Axis** settings:

Selecting **X Axis** displays the following Bode Graph Settings:

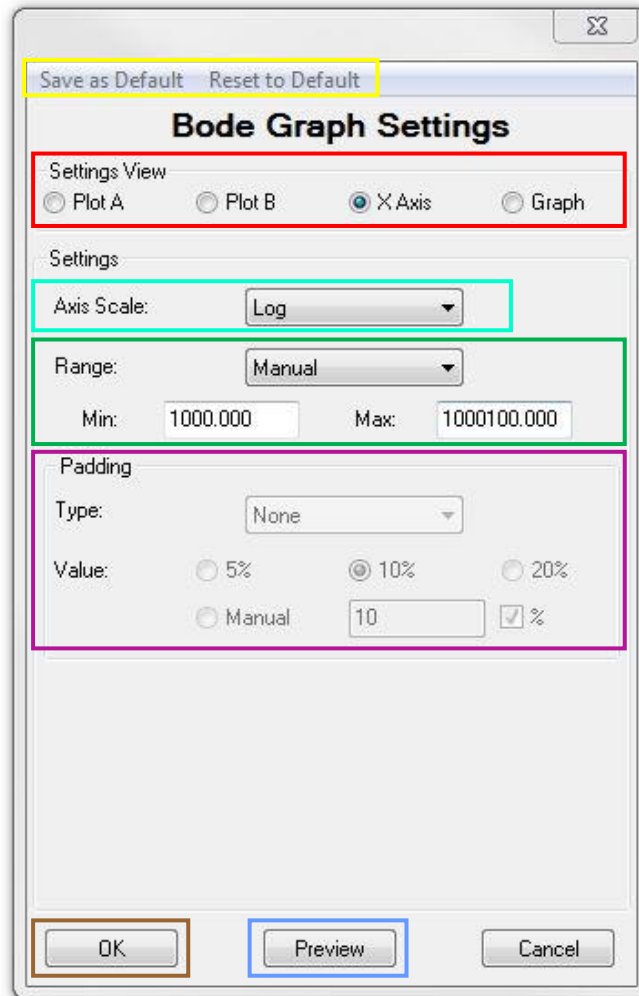

Axis Scale allows you to edit the scale of the Y-axis, there is the choice between Linear and Logarithmic.

Range allows you to change the Range (sweep start and sweep end) for the X-Axis. **Padding** allows you to change how much relief there is between the plot and the edge of the graph in both X and Y directions.

Preview allows you to view the changes on the LCR Graph, and once you're happy you can either save it as a **new default**, **reload the current default**, press **OK** or cancel to leave the graph as it was.

Bode Plot **Graph** Settings:

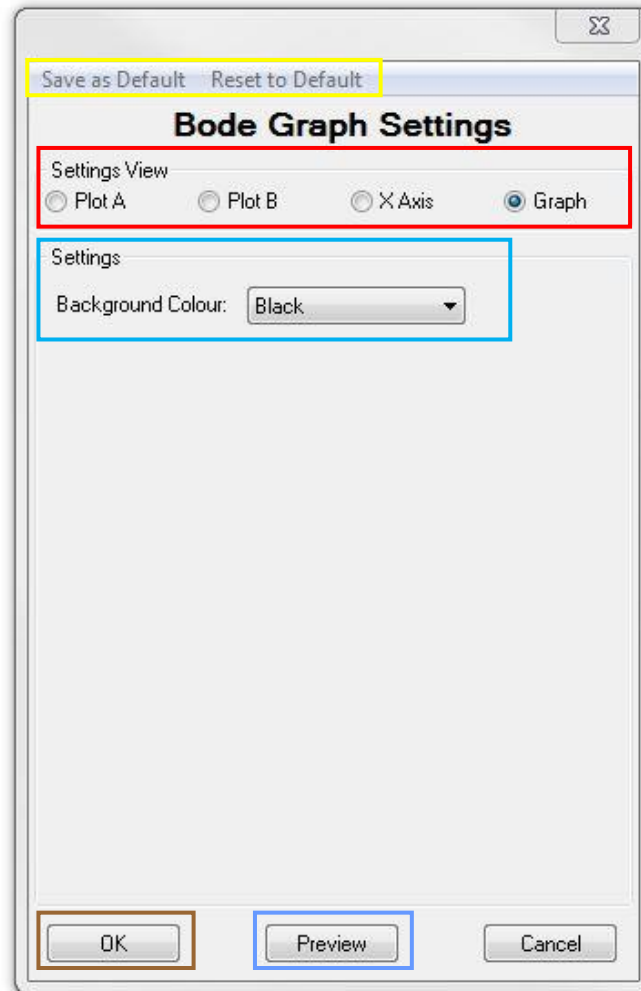

The **background colour** of the graph can be changed in the **Graph** settings. The default colour is black which can be changed to white.

Preview allows you to view the changes on the LCR Graph, and once you're happy you can either save it as a **new default**, **reload the current default**, press **OK** or cancel to leave the graph as it was.

Nyquist Graph Settings:

The settings are similar to those for Bode Graphs except there is no Plot B for the Y-axis.

7.4 Exporting LCR to CSV

To export to CSV, once the sweep is completed press the **Export** button.

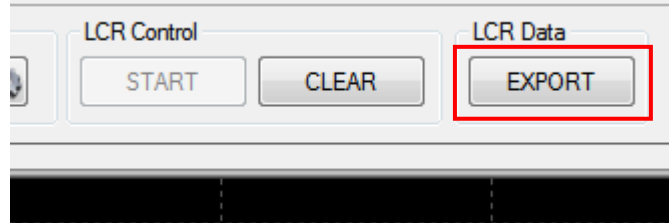

And select **Export to CSV**

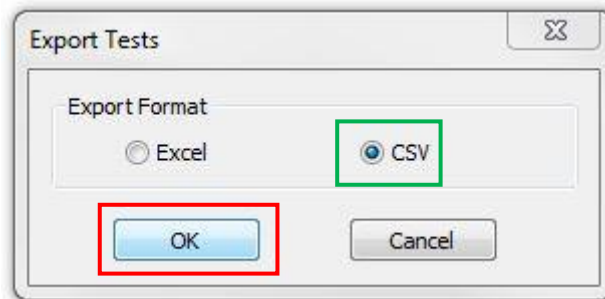

Press **OK** and PSMComm2 will ask for a file location:

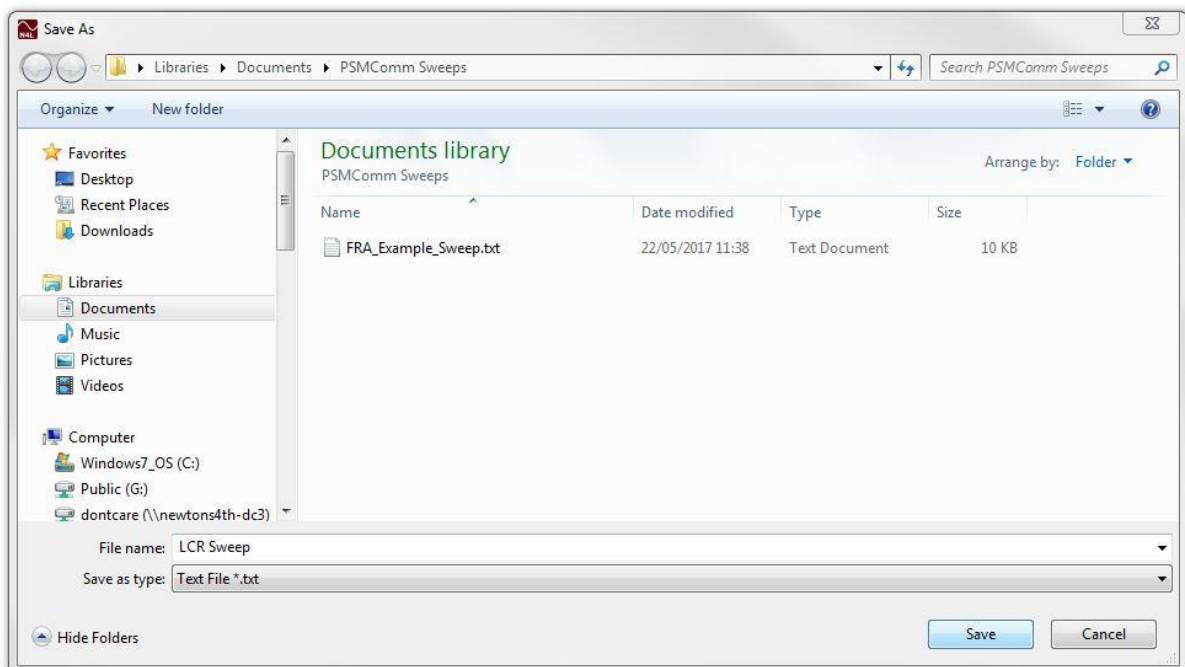

Select a file location for the data to be stored in and set a file name; finally, press Save.

7.5 Exporting LCR to Excel

To export to Excel, once the sweep is completed press the **Export** button.

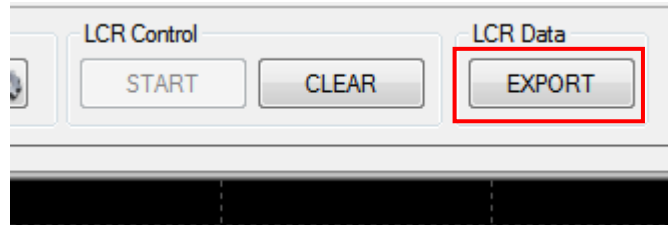

And ensure **Export to Excel** is selected then press **OK**.

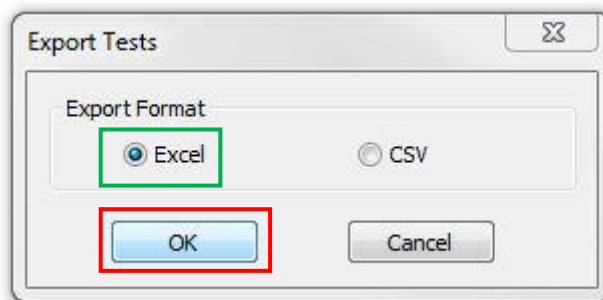

Excel will open with the step count and all the LCR data from the sweep. Excel can be used to save the data to a ".xlsx" file.

	A	B	C	D	E	F	G	H	I
1	PSMComm2 v1_1c								22nd May 2017 - 14:59:43
2	N4L PSMComm2 LCR Sweep Data 1/1								
3	Steps	Frequency	Q	Tanδ	Impedance	Phase	L	C	R
4	1	1,000.00	2.68E-01	3.73E+00	5.04E-01	1.65E+02	2.08E-05	-1.22E-03	-4.87E-01
5	2	354,530.00	1.87E+00	5.34E-01	2.35E-02	1.18E+02	9.32E-09	-2.16E-05	-1.11E-02
6	3	708,050.00	1.78E+00	5.61E-01	2.16E-02	-1.19E+02	-4.23E-09	1.19E-05	-1.06E-02
7	4	1,061,600.00	2.80E+00	3.57E-01	3.30E-02	-7.04E+01	-4.67E-09	4.82E-06	1.11E-02
8	5	1,415,100.00	2.97E+01	3.37E-02	4.35E-03	8.81E+01	4.89E-10	-2.59E-05	1.46E-04
9	6	1,768,600.00	9.21E-01	1.09E+00	1.74E-02	4.26E+01	1.06E-09	-7.63E-06	1.28E-02
10	7	2,122,200.00	3.37E-01	2.97E+00	3.59E-03	1.61E+02	8.59E-11	-6.55E-05	-3.40E-03
11	8	2,475,700.00	6.88E+00	1.45E-01	1.92E-02	9.83E+01	1.22E-09	-3.38E-06	-2.77E-03
12	9	2,829,200.00	6.53E-01	1.53E+00	9.24E-03	1.47E+02	2.84E-10	-1.11E-05	-7.74E-03
13	10	3,182,700.00	8.78E+02	1.14E-03	1.87E-02	8.99E+01	9.34E-10	-2.68E-06	2.13E-05
14	11	3,536,300.00	2.12E+01	4.72E-02	1.91E-02	9.27E+01	8.59E-10	-2.36E-06	-9.01E-04
15	12	3,889,800.00	4.23E+01	2.36E-02	1.43E-02	9.14E+01	5.86E-10	-2.86E-06	-3.39E-04
16	13	4,243,300.00	3.88E+00	2.58E-01	2.19E-02	7.56E+01	7.96E-10	-1.77E-06	5.47E-03
17	14	4,596,800.00	2.06E+00	4.85E-01	5.34E-02	6.41E+01	1.66E-09	-7.20E-07	2.33E-02
18	15	4,950,400.00	8.50E+00	1.18E-01	1.49E-02	9.67E+01	4.75E-10	-2.18E-06	-1.74E-03
19	16	5,303,900.00	5.57E+00	1.80E-01	1.32E-02	1.00E+02	3.91E-10	-2.30E-06	-2.34E-03
20	17	5,657,400.00	4.99E+00	2.00E-01	1.59E-02	1.01E+02	4.37E-10	-1.81E-06	-3.12E-03
21	18	6,010,900.00	6.46E-01	1.55E+00	2.49E-02	1.47E+02	3.57E-10	-1.96E-06	-2.09E-02
22	19	6,364,500.00	1.16E+00	8.60E-01	3.01E-02	1.31E+02	5.70E-10	-1.10E-06	-1.96E-02
23	20	6,718,000.00	1.81E+00	5.54E-01	1.87E-02	1.19E+02	3.87E-10	-1.45E-06	-9.04E-03
24	21	7,071,500.00	1.15E+00	8.72E-01	1.30E-02	1.31E+02	2.20E-10	-2.30E-06	-8.53E-03
25	22	7,425,000.00	6.95E-01	1.44E+00	1.70E-02	1.45E+02	2.08E-10	-2.21E-06	-1.40E-02

8 Piezo Mode

8.1 Introduction to Piezo Mode

Piezo mode is PSMComm2's mode for modelling a Piezoelectric Equivalent Circuit. PSMComm2 runs an LCR sweep and will calculate the values of L_s , R_s , C_s , and C_p .

8.2 Performing a Piezo Sweep

To perform a Piezo sweep, ensure you're in Piezo Mode by pressing the **Piezo** button at the top of PSMComm2.

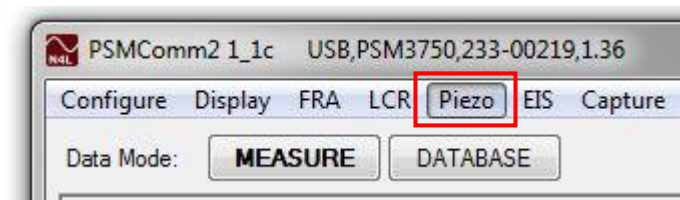

PSMComm2 will reload all the settings from the connected PSM.

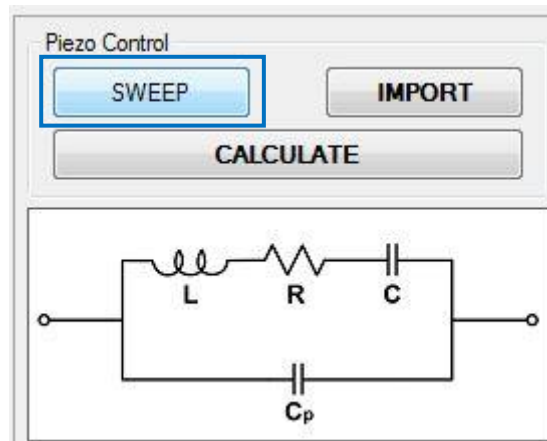

Pressing **SWEEP** will display the Test Details window:

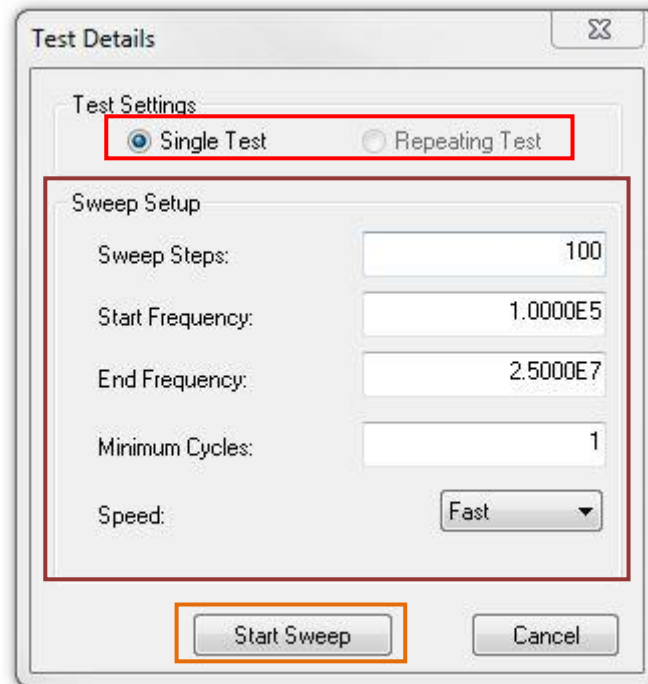

You can select to perform a **Single Test** or a **Repeating Test**.

Selecting a **Repeating Test** brings up some additional options where you can set the number of **Tests to run** and the **Interval** between sweeps starting.

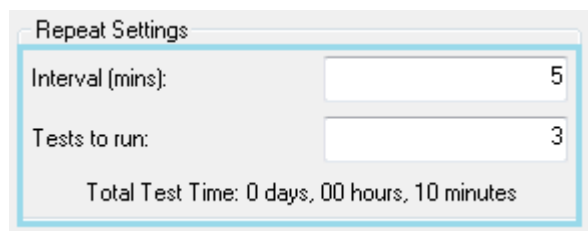

The **Sweep Setup** details can be checked and updated if necessary.

Once the sweep has been set up, press the **Start Sweep** button and PSMComm2 will start the sweep running on the connected PSM.



Once the Sweep has been performed and downloaded, PSMComm2 will show the L, R, C, and Cp values, as well as the Impedance and Phase, graphed over frequency.

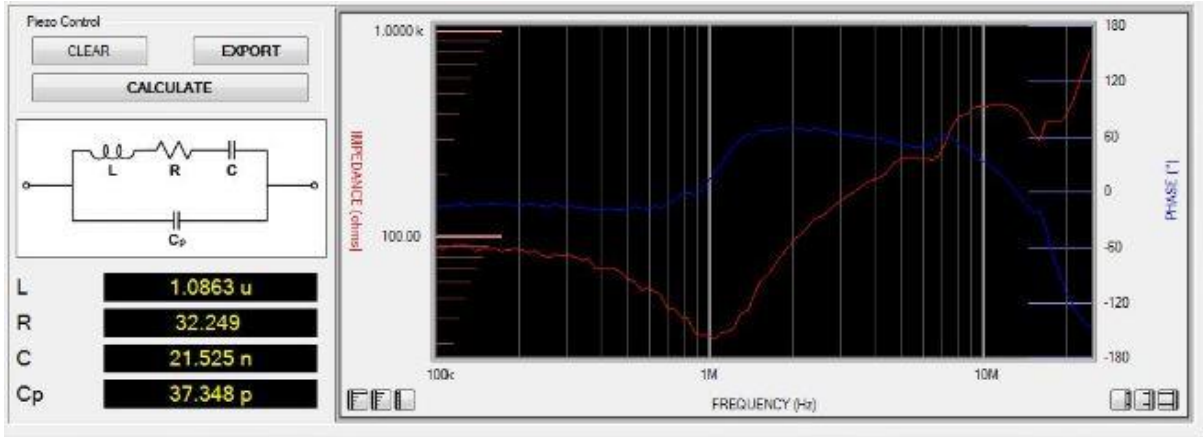

8.3 Exporting Piezo Data to CSV

To export to CSV, once the sweep is completed press the **Export** button.

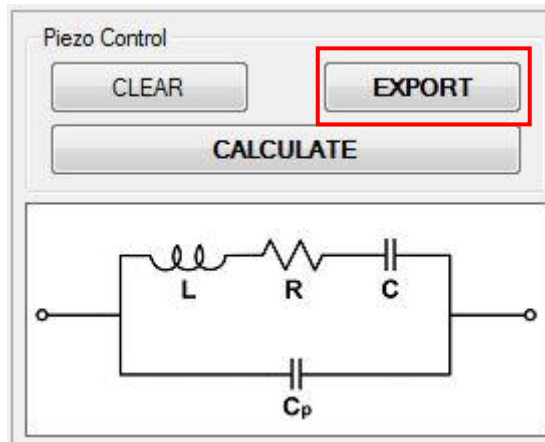

And select **Export to CSV**

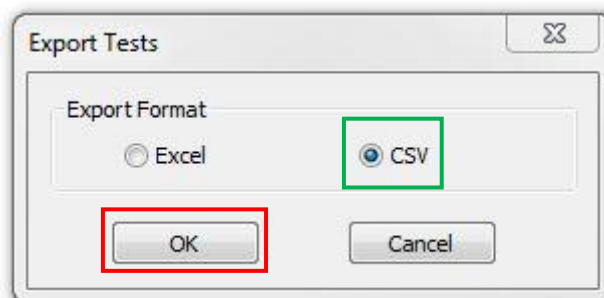

PSMComm2 Software User Manual

Press **OK** and PSMComm2 will ask for a file location:

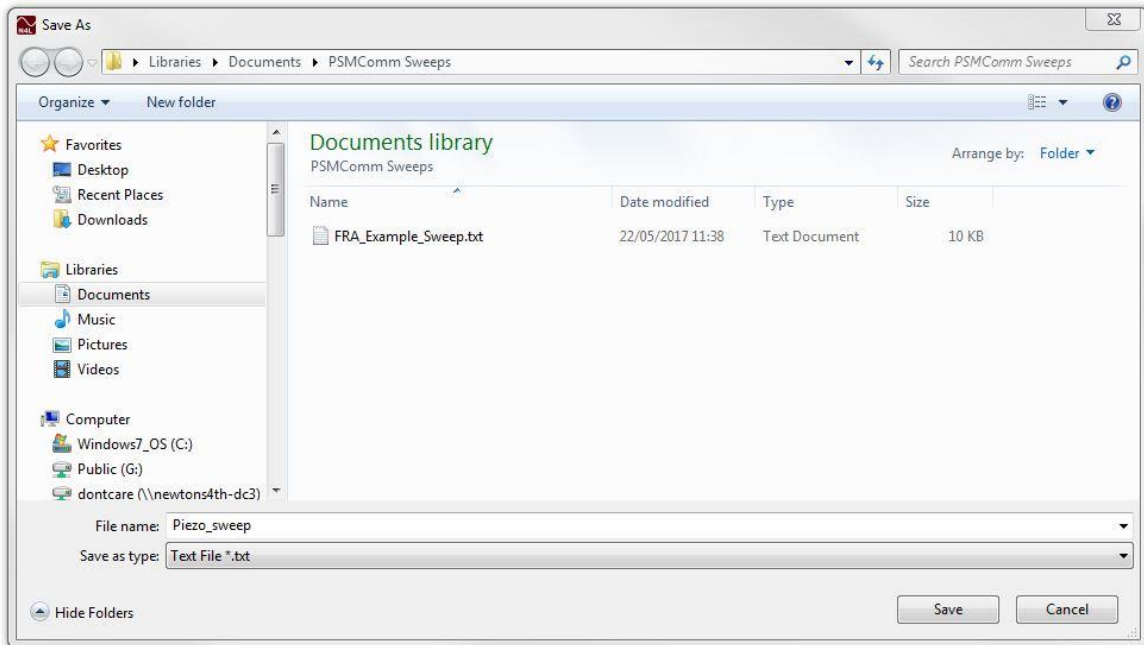

Select a file location for the data to be stored in and set a file name; finally, press Save.

8.4 Exporting Piezo Data to Excel

To export to Excel, once the sweep is completed press the **Export** button.

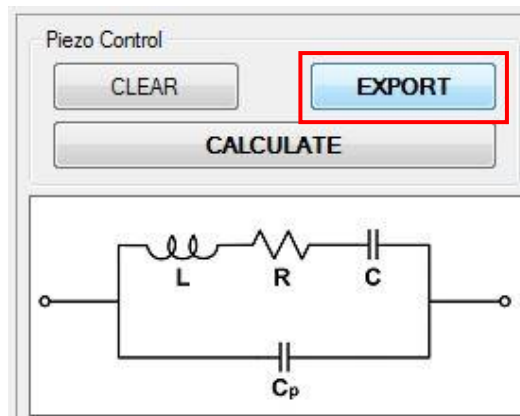

And ensure **Export to Excel** is selected then press **OK**.

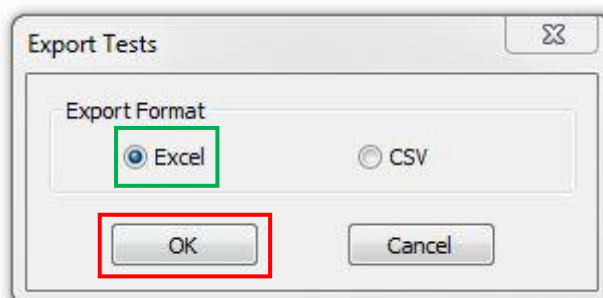

PSMComm2 Software User Manual

Excel will open with a report spread over 3 tabs:
The first tab is a report with a circuit diagram and the calculated values of L_s , R_s , C_s , and C_p :

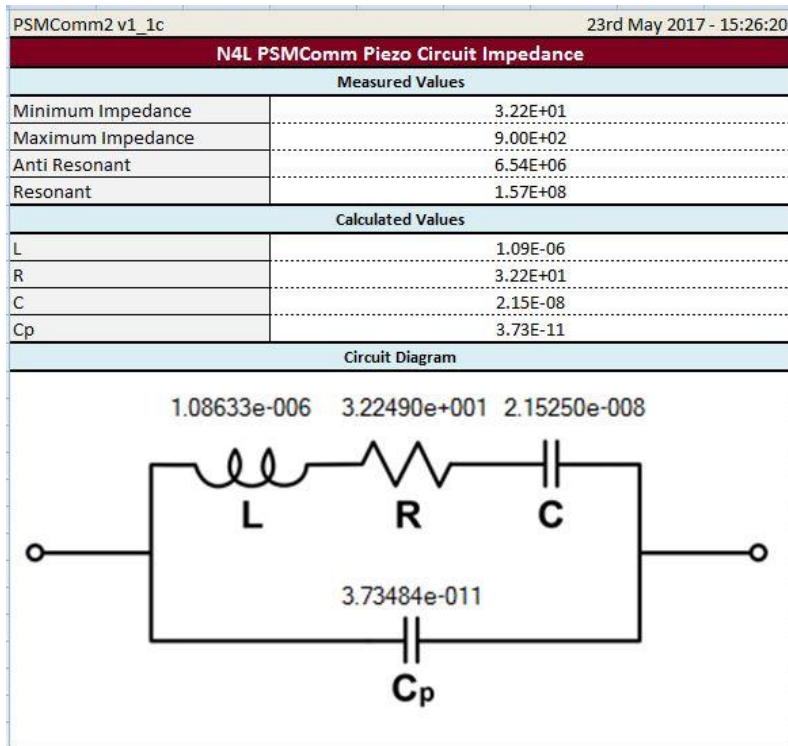

The second page is the LCR sweep data:

N4L PSMComm2 Piezo LCR Sweep Data 1/1					
Steps	Frequency	Z Real	Z Quad.	Z Mag.	Z Phase
1	100,000.00	8.88E+01	-2.53E+01	9.23E+01	-1.59E+01
2	105,740.00	8.50E+01	-2.22E+01	8.79E+01	-1.47E+01
3	111,800.00	8.75E+01	-2.31E+01	9.05E+01	-1.48E+01
4	118,210.00	8.97E+01	-2.16E+01	9.22E+01	-1.36E+01
5	125,000.00	8.96E+01	-1.94E+01	9.17E+01	-1.22E+01
6	132,160.00	8.89E+01	-2.36E+01	9.19E+01	-1.49E+01
7	139,750.00	8.40E+01	-2.08E+01	8.66E+01	-1.39E+01
8	147,760.00	8.60E+01	-2.01E+01	8.83E+01	-1.31E+01
9	156,240.00	8.64E+01	-1.95E+01	8.86E+01	-1.27E+01
10	165,200.00	8.70E+01	-1.89E+01	8.90E+01	-1.23E+01
11	174,670.00	8.34E+01	-2.02E+01	8.58E+01	-1.36E+01
12	184,690.00	8.52E+01	-2.07E+01	8.77E+01	-1.37E+01
13	195,290.00	8.54E+01	-2.28E+01	8.84E+01	-1.49E+01
14	206,490.00	8.46E+01	-2.23E+01	8.75E+01	-1.48E+01
15	218,330.00	8.25E+01	-1.76E+01	8.43E+01	-1.20E+01
16	230,860.00	8.44E+01	-2.11E+01	8.70E+01	-1.41E+01
17	244,100.00	7.92E+01	-2.06E+01	8.18E+01	-1.46E+01
18	258,100.00	7.77E+01	-2.17E+01	8.07E+01	-1.56E+01
19	272,910.00	8.07E+01	-1.76E+01	8.26E+01	-1.23E+01
20	288,560.00	7.84E+01	-2.25E+01	8.16E+01	-1.60E+01
21	305,110.00	8.05E+01	-1.99E+01	8.29E+01	-1.39E+01
22	322,610.00	7.73E+01	-2.32E+01	8.07E+01	-1.67E+01
23	341,120.00	7.48E+01	-2.12E+01	7.78E+01	-1.58E+01
24	360,690.00	7.62E+01	-2.40E+01	7.99E+01	-1.75E+01
25	381,370.00	6.69E+01	-2.32E+01	7.08E+01	-1.91E+01

And the third tab is the graph:

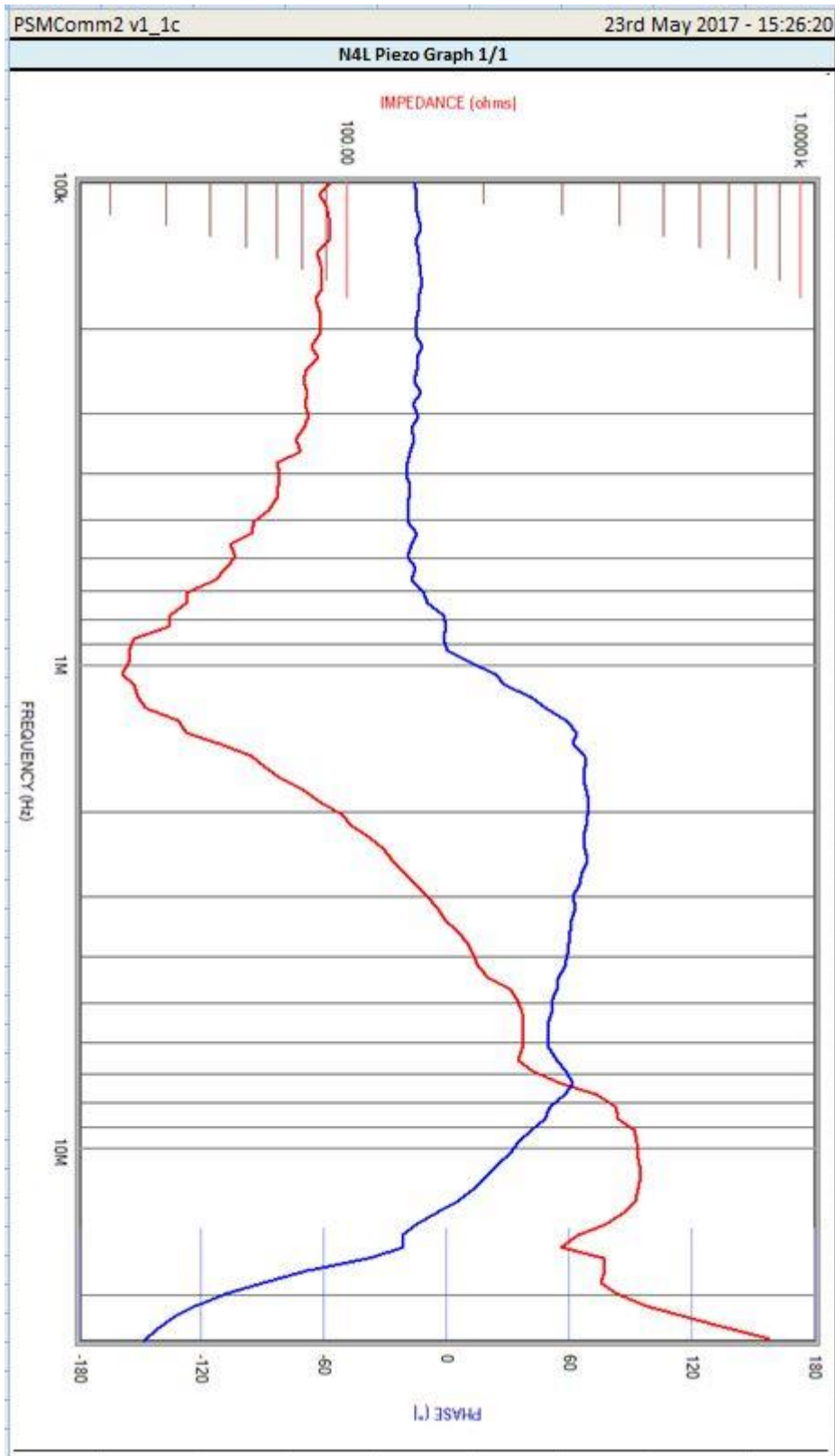

8.5 Importing into Piezo mode

To import LCR data into Piezo mode press the **Import** button

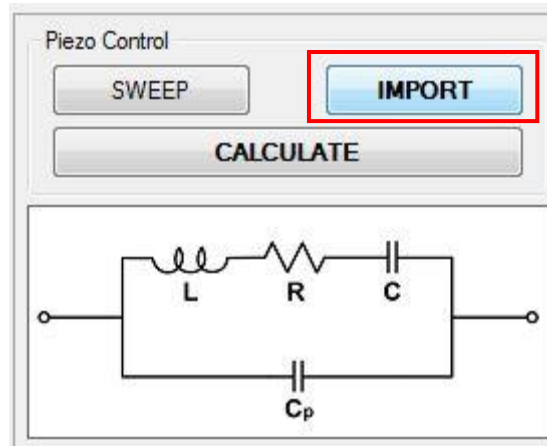

PSMComm2 will then ask for a CSV file, select a Piezo CSV exported from PSMComm2 to load in as a Piezo sweep.

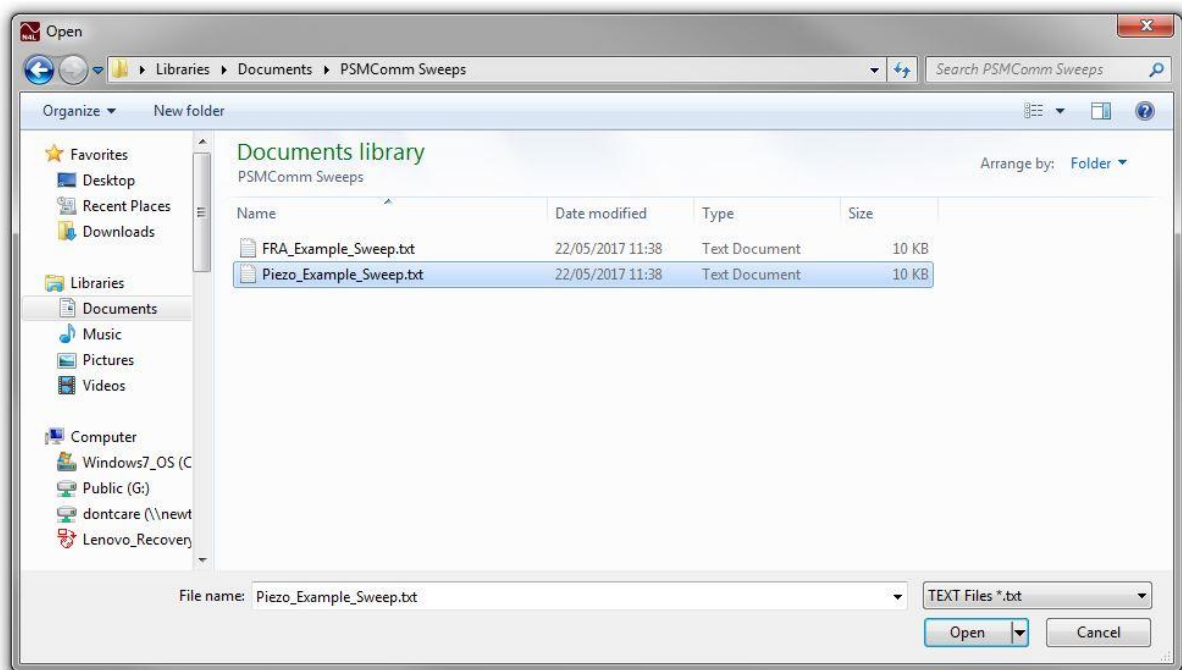

And PSMComm2 will import it and calculate the Piezo Equivalent Circuit values.

This data can be re-exported to Excel or CSV.

8.6 Piezo mode Calculate function

A sweep generated in another mode (other than FRA) can be viewed in Piezo mode and the values of L_s , R_s , C_s , and C_p calculated without the requirement to perform another sweep.

Change to Piezo Mode by pressing the **Piezo** button in the top corner of the PSMComm2 window. Piezo mode will be displayed and the graph will be updated using the sweep data from the previous mode setting.

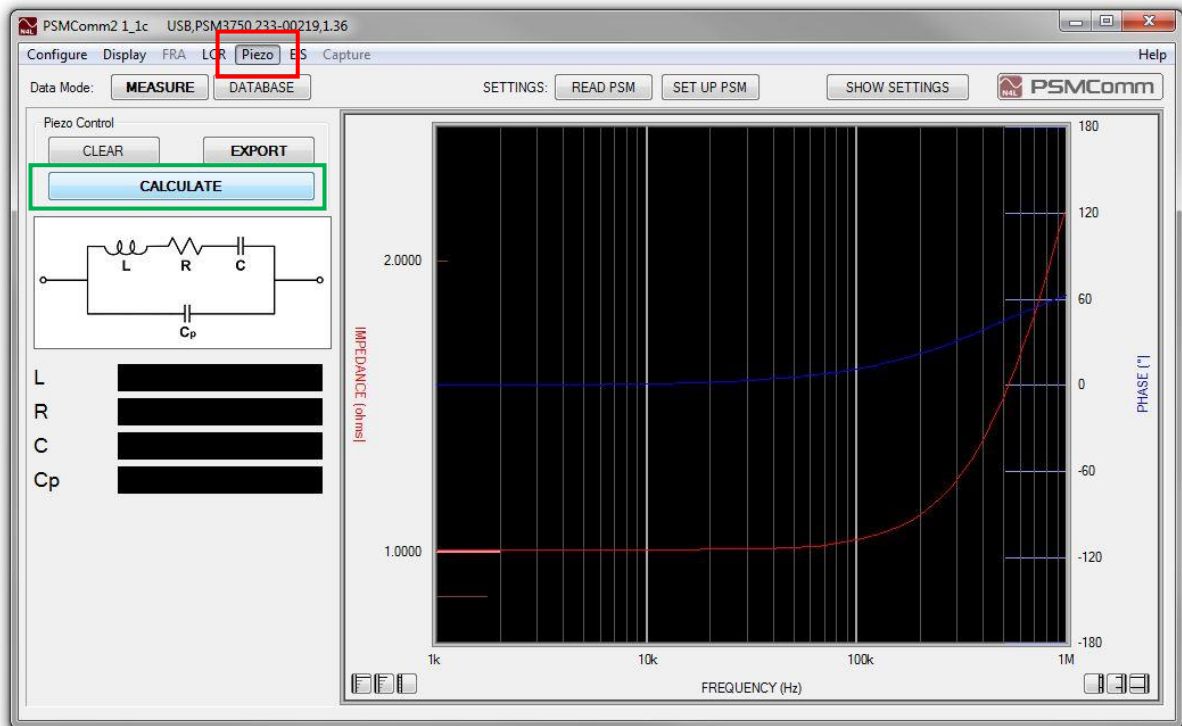

Click on **Calculate** to determine the values of L_s , R_s , C_s , and C_p which will then be displayed.

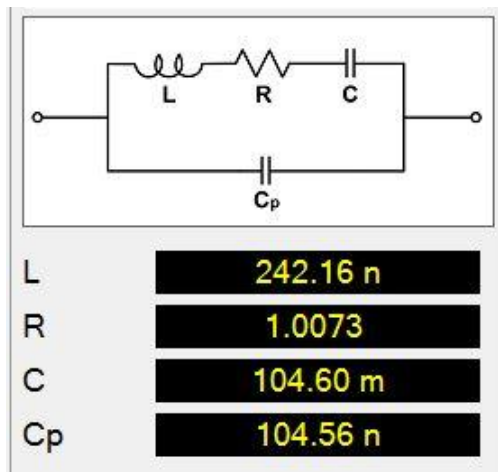

9 EIS Mode

9.1 Introduction to EIS Mode

EIS mode is PSMComm2's Electrochemical Impedance Spectroscopy mode that is used to model Randles Cell equivalent circuit values: R_s , R_p , C_p .

In this mode, PSMComm2 automatically sets the following values on Ch2 of the PSM, (Input=external shunt, Scale factor=1.0 and the shunt value = 470mOhms)

9.2 Performing an EIS Sweep

To perform an EIS sweep, ensure you're in EIS Mode by pressing the **EIS** button at the top of PSMComm2

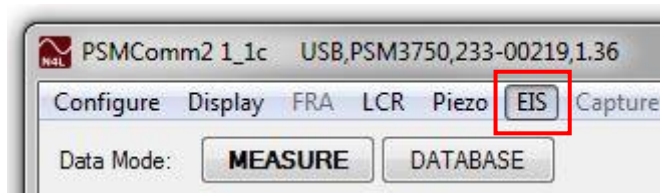

PSMComm2 will reload all the settings from the connected PSM.

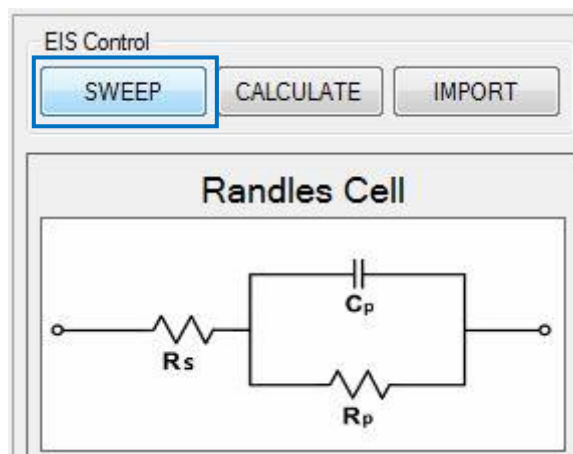

Press **SWEEP** to bring up the Test Details window:

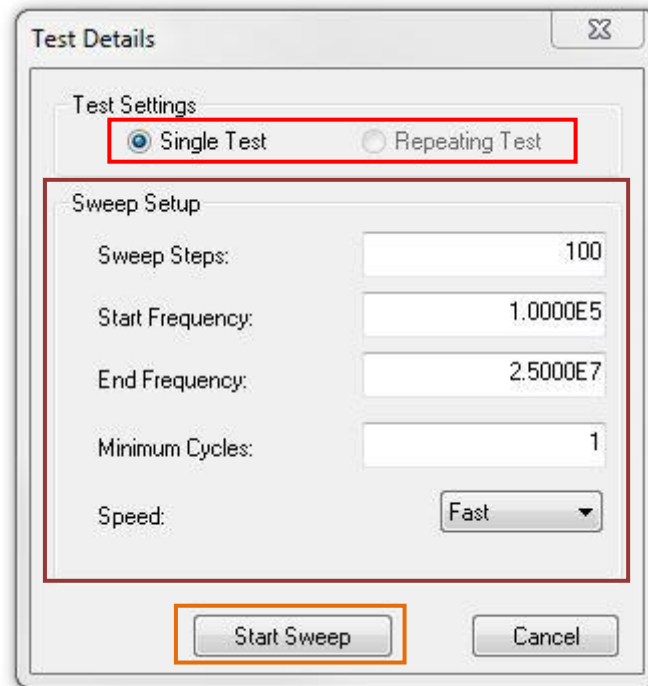

You can select to perform a **Single Test** or a **Repeating Test**.

Selecting a **Repeating Test** brings up some additional options where you can set the number of **Tests to run** and the **Interval** between sweeps starting.

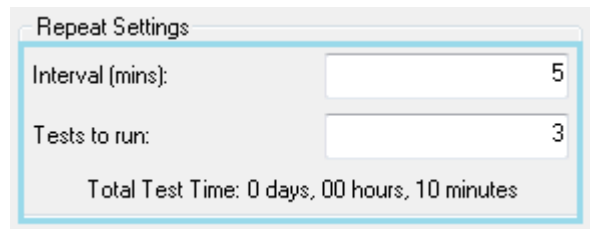

The **Sweep Setup** details can be checked and updated if necessary.

Once the sweep has been set up, press the **Start Sweep** button and PSMComm2 will start the sweep running on the connected PSM.

PSMComm2 Software User Manual

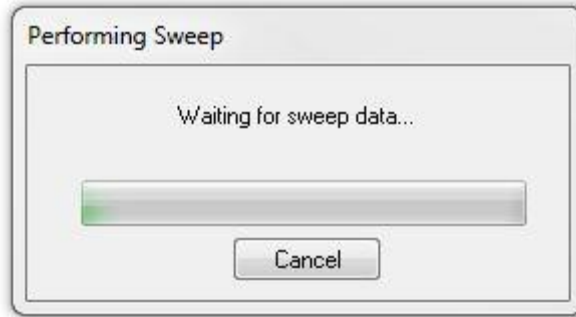

With the Sweep downloaded, PSMComm2 will display the Nyquist plot of the LCR data and the R_s , R_p , and C_p values

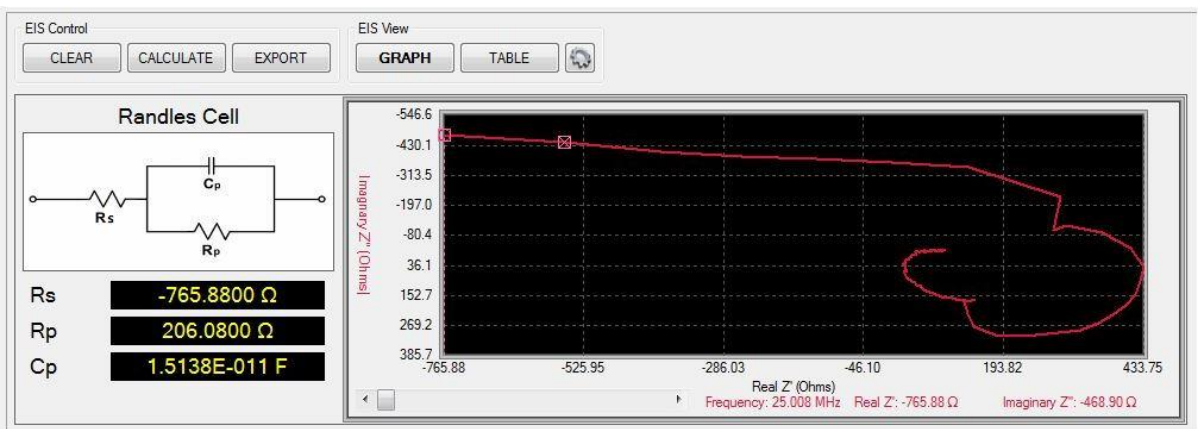

9.3 Graph Settings

To change the visual settings of the EIS Graph, press the **Graph Settings** button.

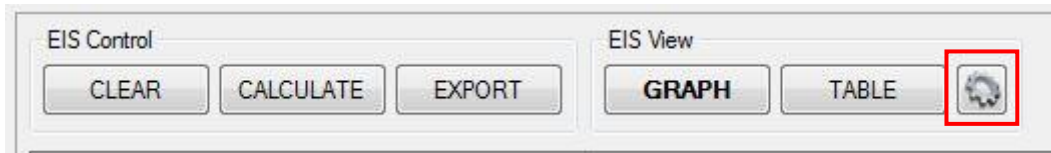

This brings up the Graph Settings window:

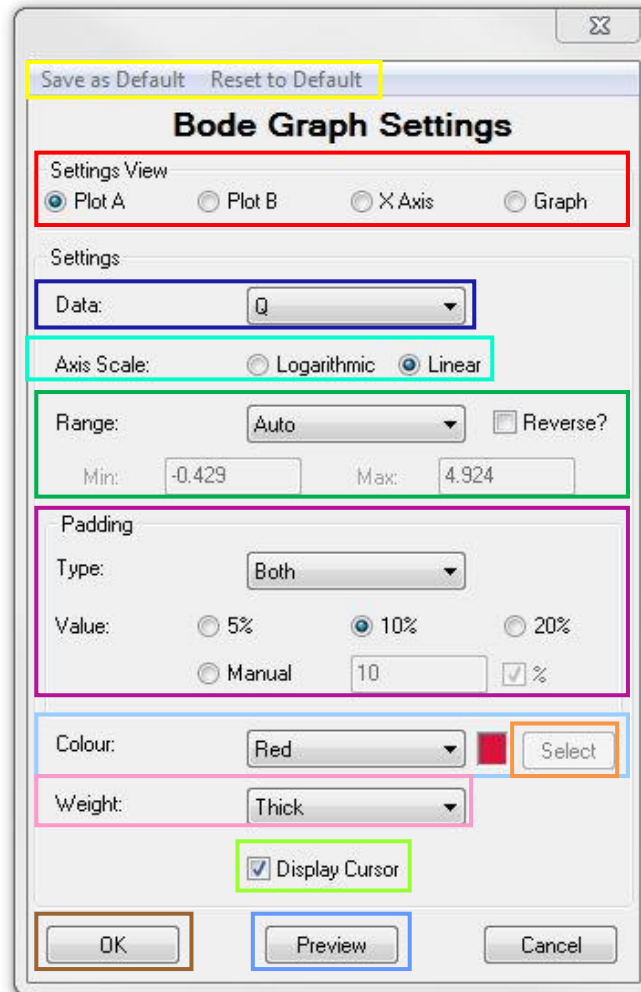

All the options in the graph settings window are available by right-clicking the graph

The Graph Settings window allows you to choose the style of Y-Axis Plots, the **X-Axis**, and the general **Graph** style, **Plot A** controls the left Y-Axis and **Plot B** controls the right Y-Axis. **Data** allows you to select which data the plot will graph. **Axis Scale** allows you to edit the scale of the Y-axis (**Plot A** and **Plot B**) and the **X-Axis**; there is the choice between Linear and Logarithmic. **Range** will allow you to change the Range of both left and right Y-Axis as well as the X-Axis, while **Padding** allows you to change how much relief there is between the plot and the edge of the graph in both X and Y directions.

For additional customisation, you can change the **colour** (including **selecting a custom colour**) and **weight** of both of the Y plots as well as being able to turn the **plot cursors** on and off for both Y plots.

The **background colour** of the graph can be changed in the Graph settings.

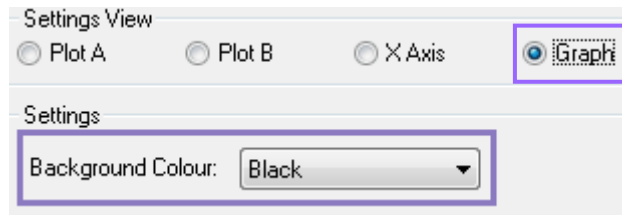

Preview allows you to view the changes on the LCR Graph, and once you're happy you can either save it as a **new default**, **reload the current default**, press **OK** or cancel to leave the graph as it was.

9.4 Exporting EIS Data to CSV

To export to CSV, once the sweep is completed press the **Export** button.

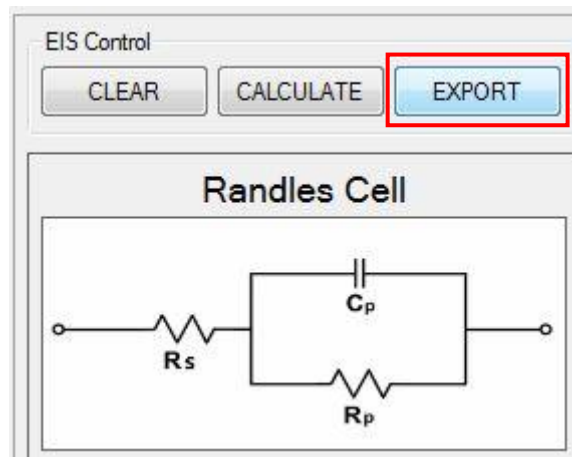

And select **Export to CSV**

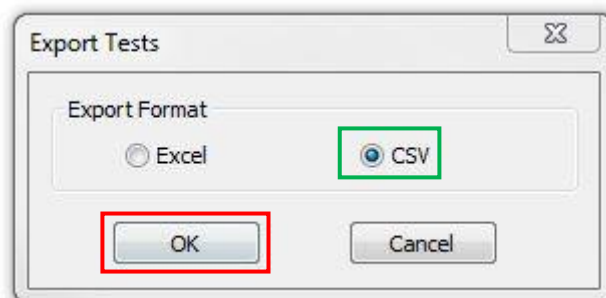

Press **OK** and PSMComm2 will ask for a file location:

PSMComm2 Software User Manual

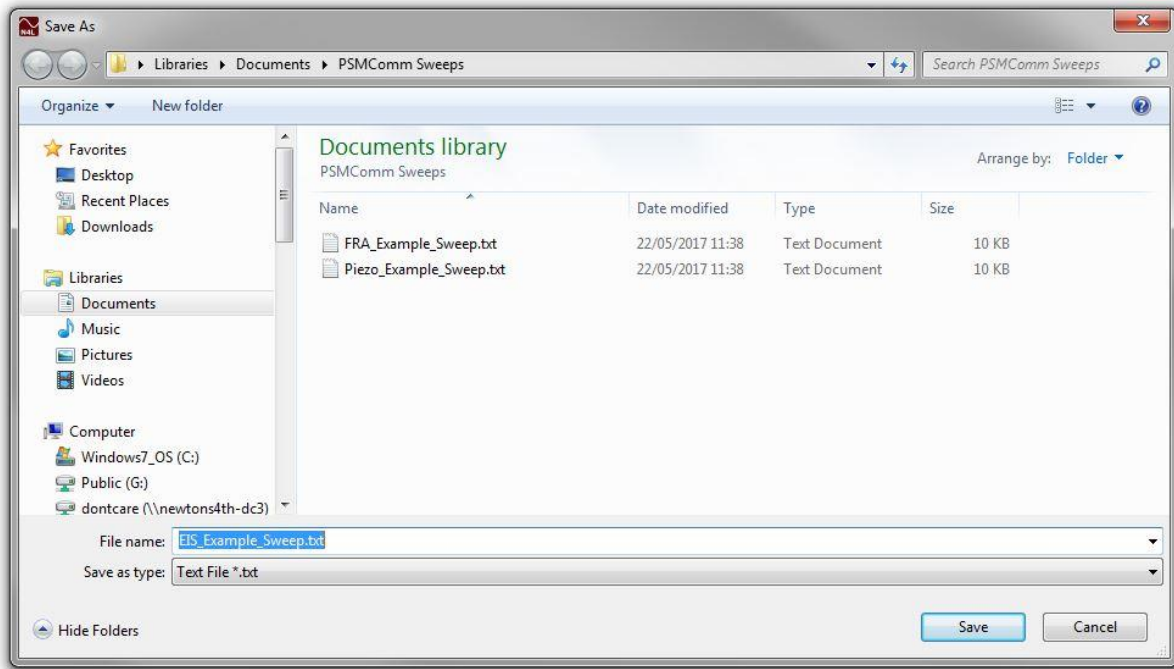

Select a file location for the data to be stored in and set a file name; finally, press Save.

9.5 Exporting EIS Data to Excel

To export to Excel, once the sweep is completed press the **Export** button.

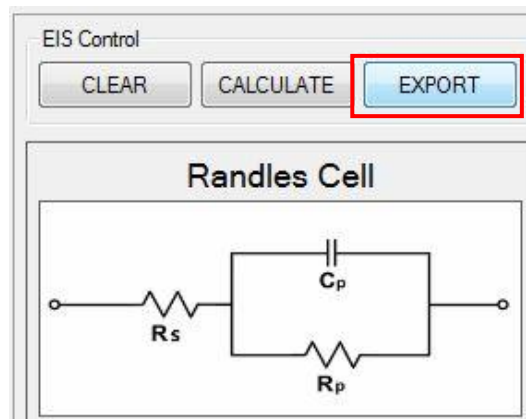

And ensure **Export to Excel** is selected and press **OK**.

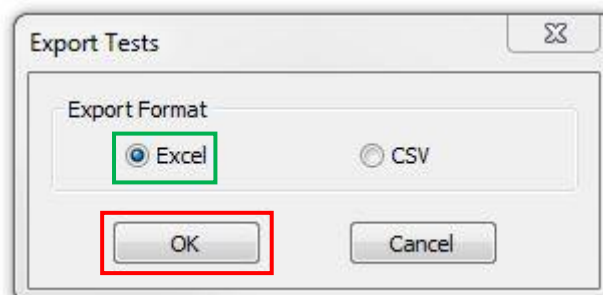

PSMComm2 Software User Manual

Excel will open with a report spread over 4 tabs:

The first tab is a report with a circuit diagram and the C_p , R_p , and R_s values on it:

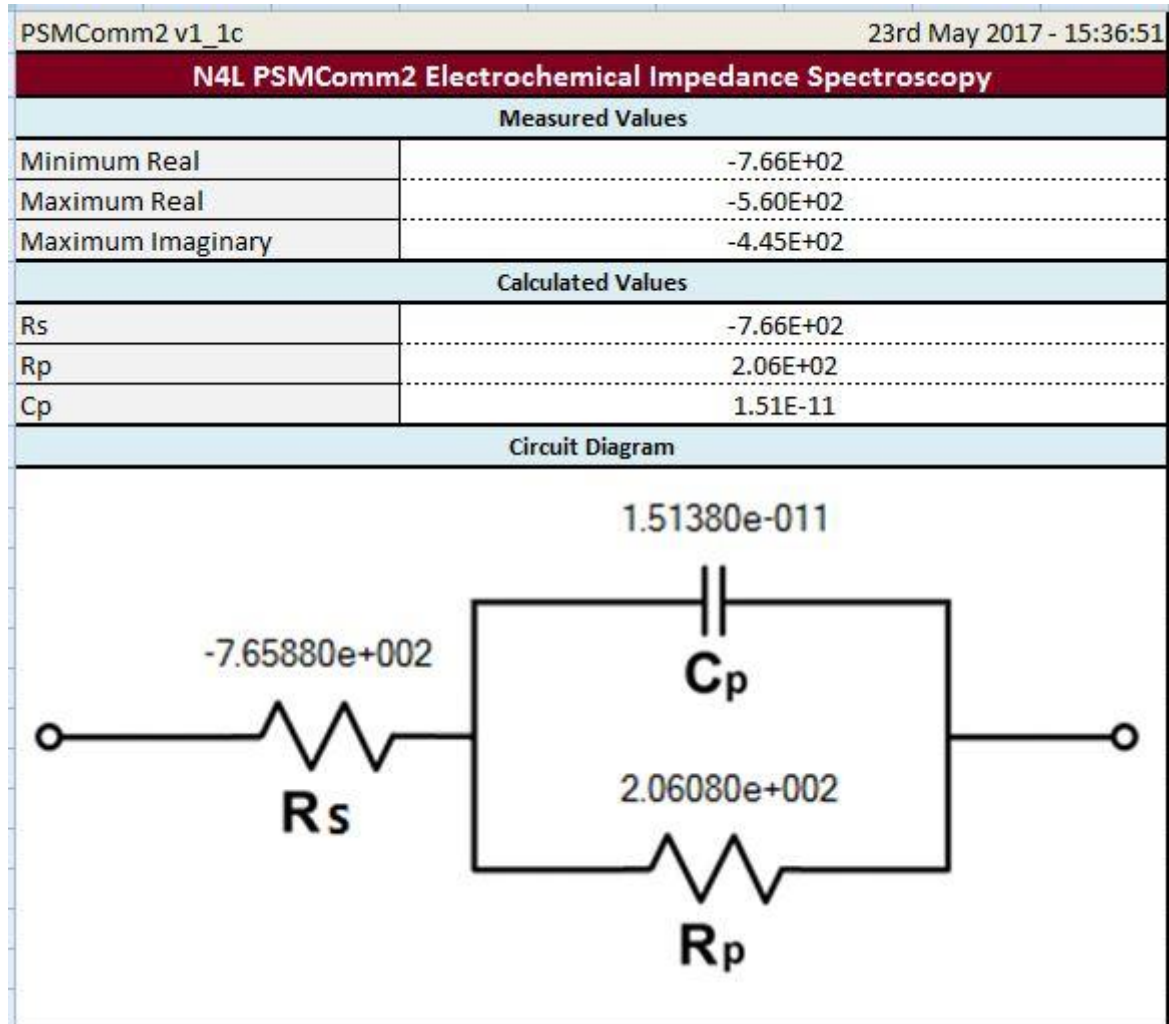

PSMComm2 Software User Manual

The second tab is a page with the LCR sweep results on it:

A		B		C		D		E		F	
PSMComm2 v1_1c						23rd May 2017 - 15:36:51					
N4L PSMComm2 EIS LCR Sweep Data 1/1											
Steps	Frequency	Z Real	Z Quad.	Z Mag.	Z Phase						
1	100,000.00	9.14E+01	-2.60E+01	9.50E+01	-1.59E+01						
2	105,740.00	9.32E+01	-2.38E+01	9.62E+01	-1.43E+01						
3	111,800.00	8.59E+01	-2.20E+01	8.87E+01	-1.44E+01						
4	118,210.00	9.08E+01	-2.10E+01	9.32E+01	-1.30E+01						
5	125,000.00	8.85E+01	-2.27E+01	9.14E+01	-1.44E+01						
6	132,160.00	8.70E+01	-2.13E+01	8.96E+01	-1.38E+01						
7	139,750.00	8.61E+01	-2.11E+01	8.87E+01	-1.38E+01						
8	147,760.00	8.93E+01	-2.00E+01	9.15E+01	-1.26E+01						
9	156,240.00	8.79E+01	-2.23E+01	9.07E+01	-1.42E+01						
10	165,200.00	8.52E+01	-2.10E+01	8.77E+01	-1.38E+01						
11	174,670.00	8.43E+01	-1.90E+01	8.64E+01	-1.27E+01						
12	184,690.00	8.58E+01	-2.09E+01	8.83E+01	-1.37E+01						
13	195,290.00	8.44E+01	-2.14E+01	8.71E+01	-1.42E+01						
14	206,490.00	8.48E+01	-2.17E+01	8.75E+01	-1.44E+01						
15	218,330.00	8.11E+01	-2.19E+01	8.40E+01	-1.51E+01						
16	230,860.00	8.01E+01	-1.99E+01	8.25E+01	-1.39E+01						
17	244,100.00	7.54E+01	-2.08E+01	7.82E+01	-1.54E+01						
18	258,100.00	8.13E+01	-2.03E+01	8.38E+01	-1.40E+01						
19	272,910.00	7.88E+01	-2.07E+01	8.15E+01	-1.47E+01						
20	288,560.00	7.71E+01	-2.23E+01	8.03E+01	-1.61E+01						

The Third tab is a page with the Imaginary and Real data used to create the Nyquist plot:

A		B		C		D		E		F	
PSMComm2 v1_1c						23rd May 2017 - 15:36:51					
N4L PSMComm2 EIS Nyquist Data 1/1											
Steps	Frequency	Real (Z')	Imaginary (Z'')								
1	100,000.00	9.14E+01	-2.60E+01								
2	105,740.00	9.32E+01	-2.38E+01								
3	111,800.00	8.59E+01	-2.20E+01								
4	118,210.00	9.08E+01	-2.10E+01								
5	125,000.00	8.85E+01	-2.27E+01								
6	132,160.00	8.70E+01	-2.13E+01								
7	139,750.00	8.61E+01	-2.11E+01								
8	147,760.00	8.93E+01	-2.00E+01								
9	156,240.00	8.79E+01	-2.23E+01								
10	165,200.00	8.52E+01	-2.10E+01								
11	174,670.00	8.43E+01	-1.90E+01								
12	184,690.00	8.58E+01	-2.09E+01								
13	195,290.00	8.44E+01	-2.14E+01								
14	206,490.00	8.48E+01	-2.17E+01								
15	218,330.00	8.11E+01	-2.19E+01								
16	230,860.00	8.01E+01	-1.99E+01								
17	244,100.00	7.54E+01	-2.08E+01								

PSMComm2 Software User Manual

The final tab is a page with the Nyquist graph on:

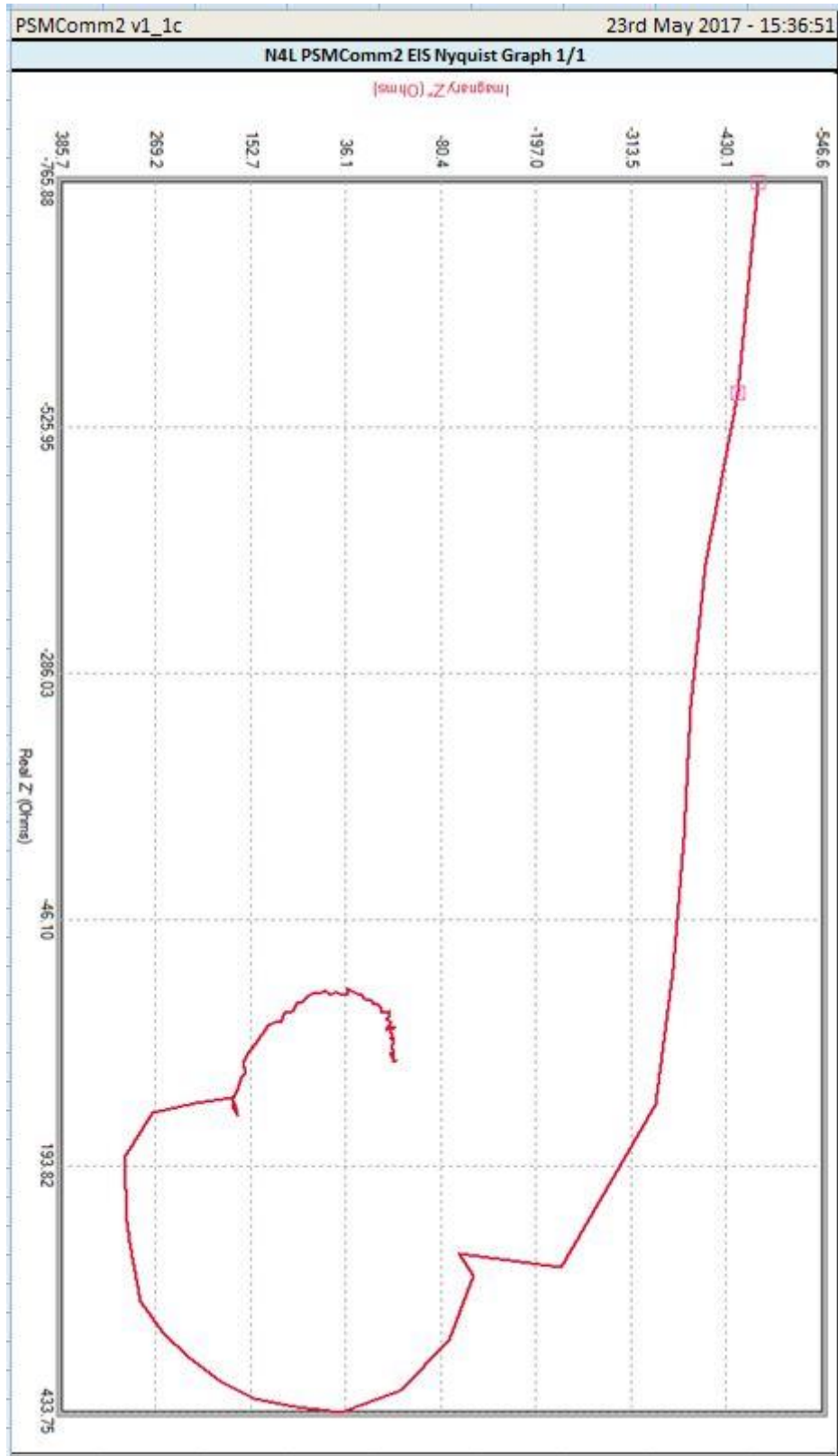

9.6 Importing into EIS mode.

To import LCR data into EIS mode press the **Import** button

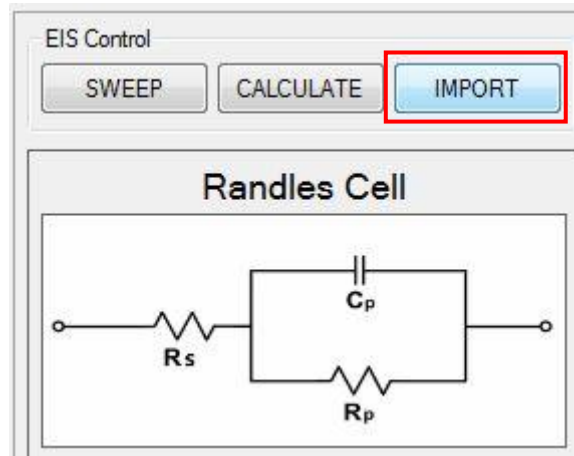

PSMComm2 will then ask for a CSV file, select an EIS CSV exported from PSMComm2 to load in as an EIS sweep.

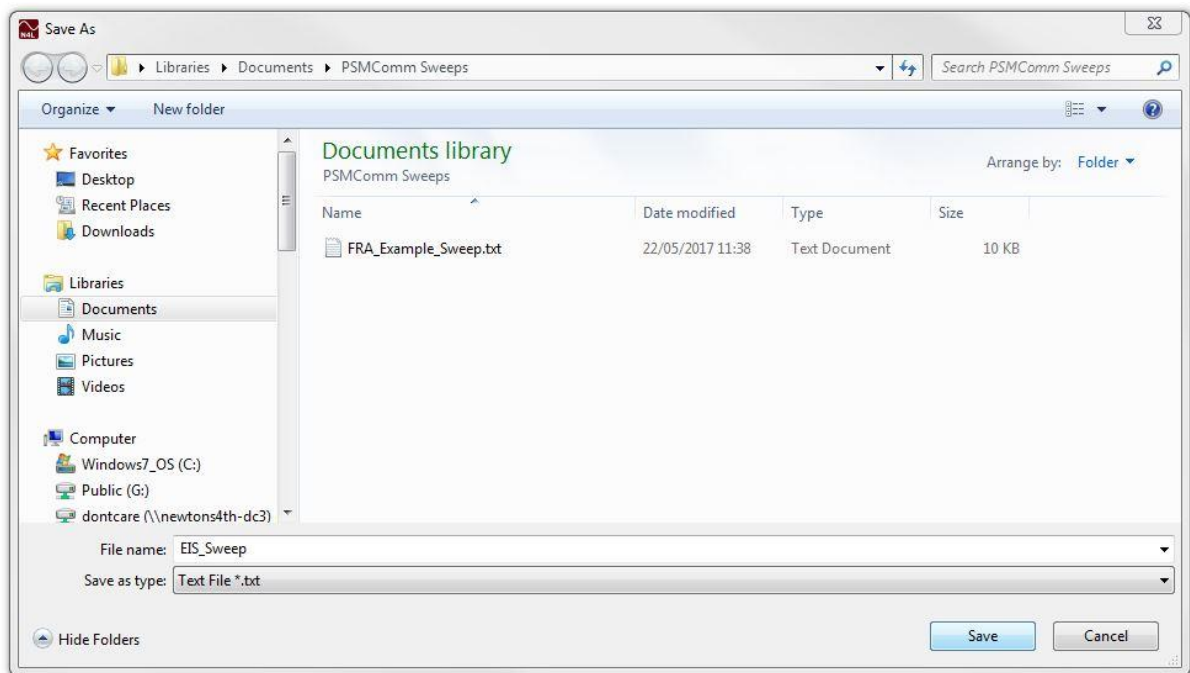

And PSMComm2 will import it and calculate the EIS Equivalent Circuit values.

This data can be re-exported to Excel or CSV.

9.7 EIS mode Calculate function

A sweep generated in another mode (other than FRA) can be viewed in EIS mode and the values of R_s , R_p , C_p can be determined without the requirement to perform another sweep.

Change to EIS Mode by pressing the **EIS** button in the top corner of the PSMComm2 window. EIS mode will be displayed and the graph will be updated using the sweep data from the previous mode setting.



Click on **Calculate** to determine the values of R_s , R_p , C_p which will then be displayed.

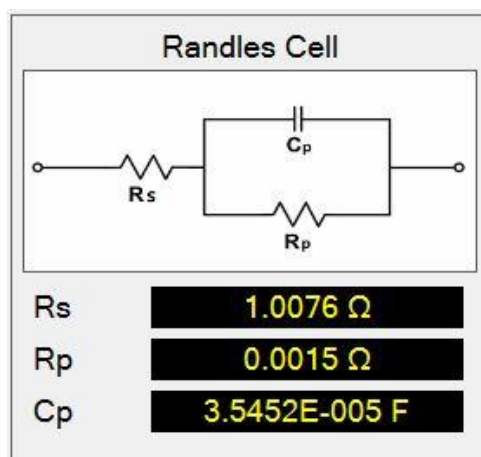

10 PSMComm2 Database

10.1 Introduction to the PSMComm2 Database

PSMComm2's database is used for storing FRA plots in a reliable and reusable way. The plots can be exported to CSV & Excel as well as graphed. Multiple FRA sweeps can be graphed together and calculations can be run on database FRA plots.

To Access the PSMComm2's database system, press the **DATABASE** button just under the menu.

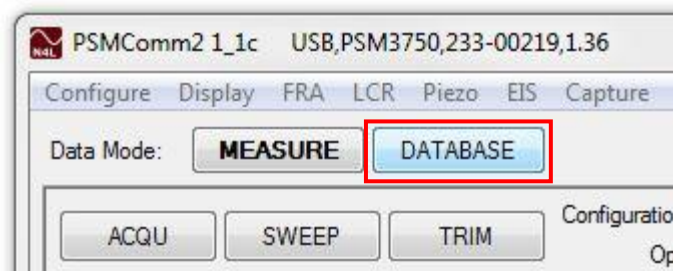

This will show you the PSMComm2 database view:

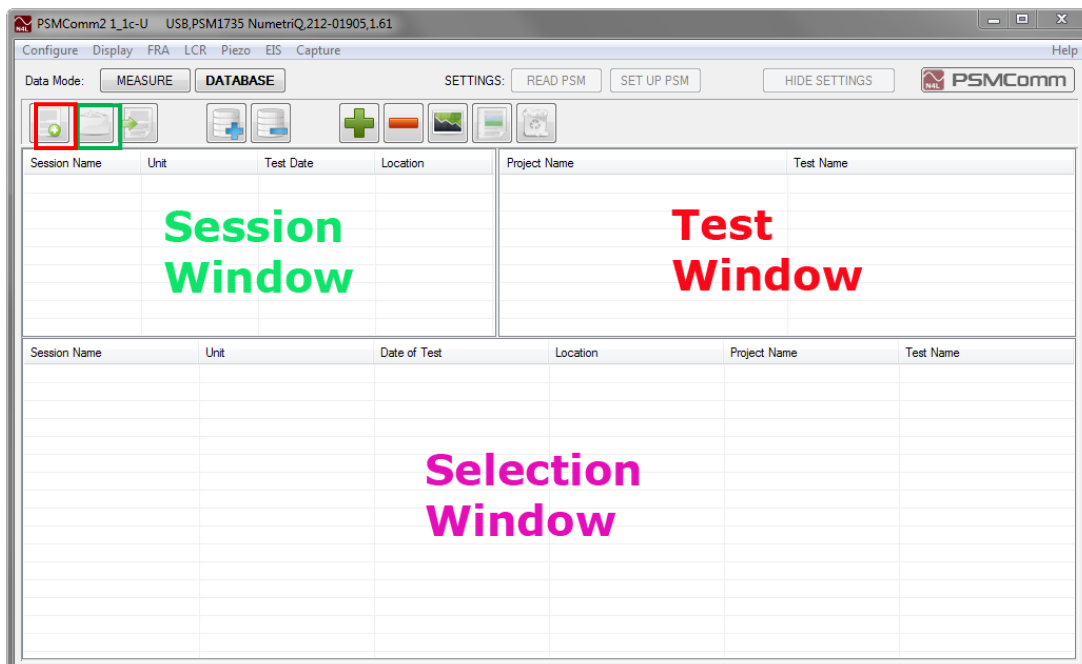

When you first open PSMComm2 it will create a new database for you called "default.db" and place this in the same location as PSMComm2's .exe file, however, if you want to make a new database you can with the **New Database** button.

Open Database Allows you to swap the database you're editing to another database created by PSMComm2.

10.2 Adding a Session to the database

All tests added to a PSMComm2 database must be part of a session.

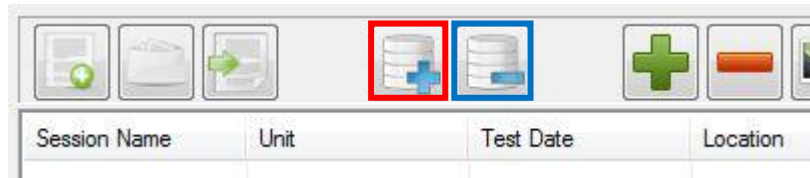

The **Create Session** button allows you to create a new testing session for tests to be added to. When Create Session is pressed, the Create Session window is displayed:

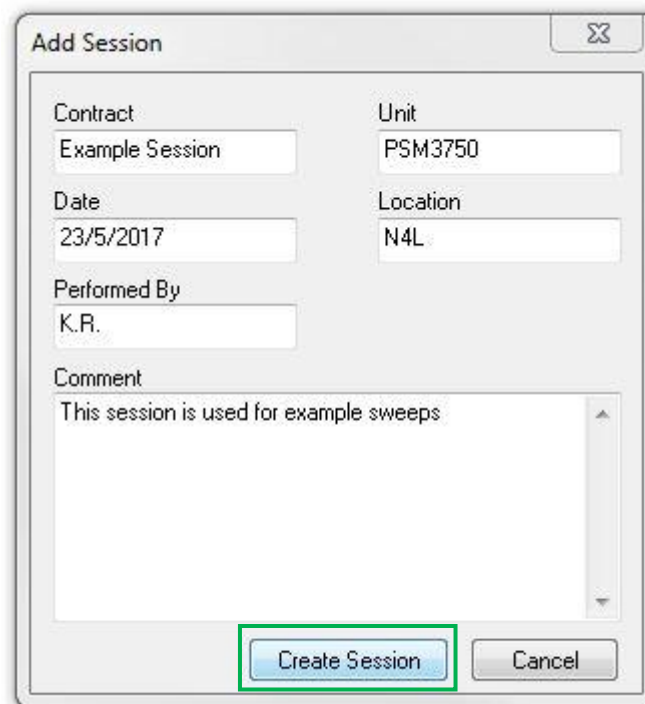
A screenshot of the 'Add Session' dialog box. The dialog has a title bar with the text 'Add Session' and a close button. It contains several input fields: 'Contract' with the value 'Example Session', 'Unit' with the value 'PSM3750', 'Date' with the value '23/5/2017', 'Location' with the value 'N4L', and 'Performed By' with the value 'K.R.'. There is also a 'Comment' text area containing the text 'This session is used for example sweeps'. At the bottom of the dialog, there are two buttons: 'Create Session' (highlighted with a green box) and 'Cancel'.

Fill in the details and press **Create Session** to add the new session to the database. This will show in the **Session Window**

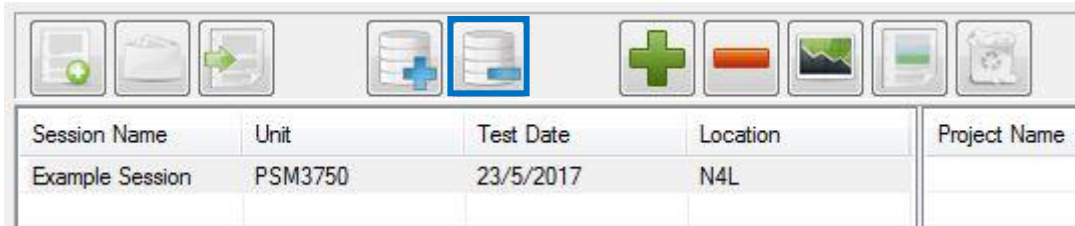

Sessions and all related tests can be deleted by using the [Delete Session](#) button.

10.3 Adding a Test to the Database

To Add a test to the PSMComm2 database, an FRA sweep must be performed, to do this we will need to enter **Measure** mode again:

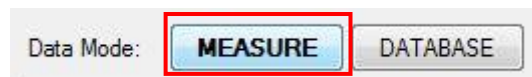

FRA mode will also need to be selected:



Sweeps can only be performed when Graph or Table View modes are selected:

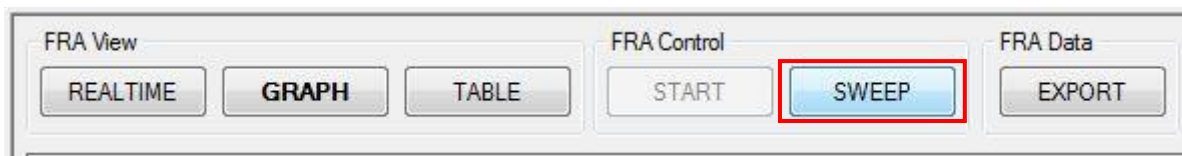

Click on **Sweep** to display the Test Details Window:

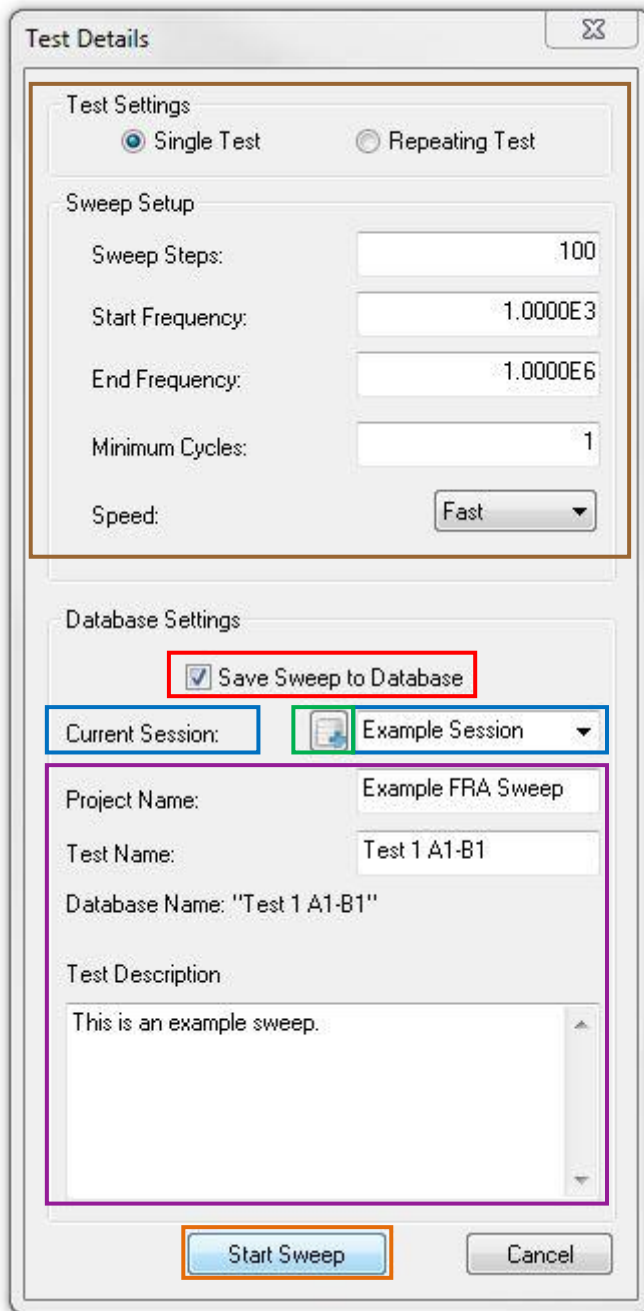

Check and update the **Test Settings** if required.

Enable **Save Sweep to Database**

Select a **Current Session** from the **drop down menu** or use the **Create Session** function for this test to be added.

Enter the remaining test details.

Press **Start Sweep** to start the Sweep running.

Full details on FRA Sweeps can be found in section 6.2

Once the Sweep has finished click on **DATABASE** to return to the Database display.

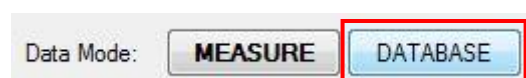

PSMComm2 Software User Manual

On the Database screen, select the **Session name** that the Sweep was added to:

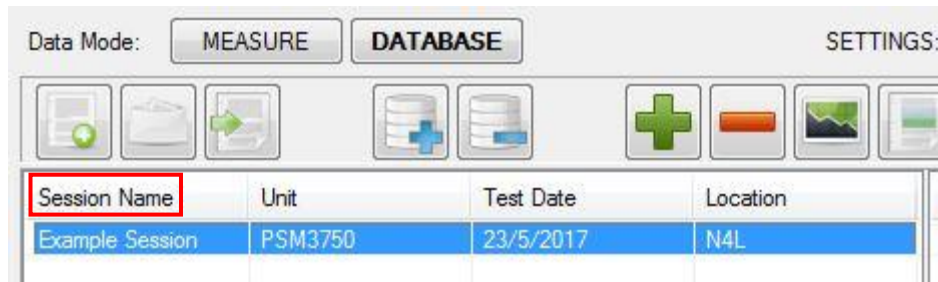

The new Sweep will have been added to the Database. It will have the **Project Name** and **Test Name** entered when the Sweep was performed.

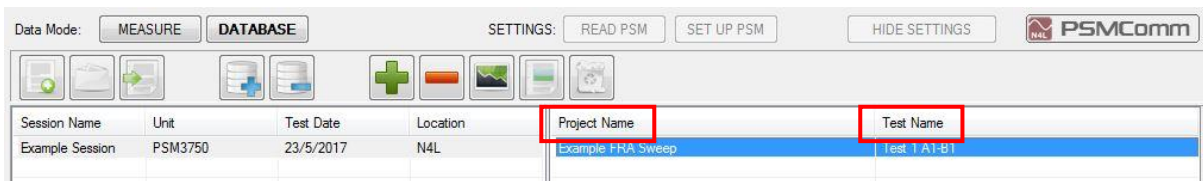

The sweep will show in the [Test Window](#)

10.4 Removing a Test from the Database

To delete a test from the PSMComm2 Database, select the test you want to remove and then press the **Delete Test** button:

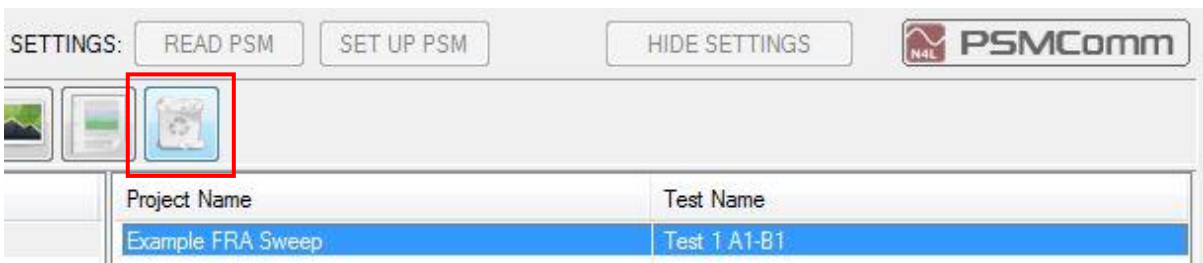

You will be asked to confirm you want to delete the test. Press **"Yes"** to delete the test.

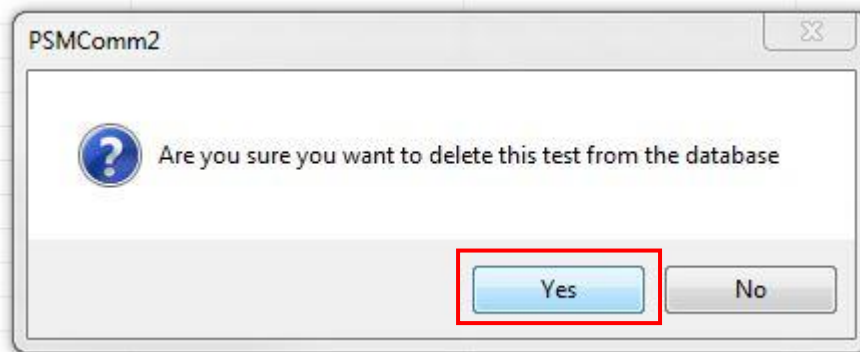

The test is then deleted from the database.

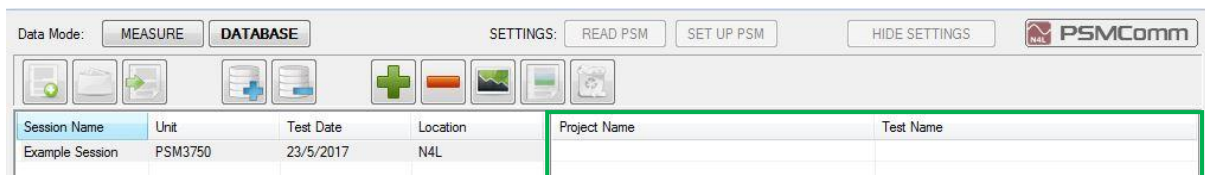

10.5 Exporting a Database Test to CSV

To export tests from the PSMComm2 Database to CSV files, first select the tests to be exported. This can be done by clicking on the test to be exported and pressing the **Add Test to Selection** button:



Multiple tests can be exported so this process should be repeated until all required tests have been selected. Alternatively, double-clicking on the test will select it.

PSMComm2 Software User Manual

The selected tests will then appear in the lower part of the Database window, the **Selection Window**.

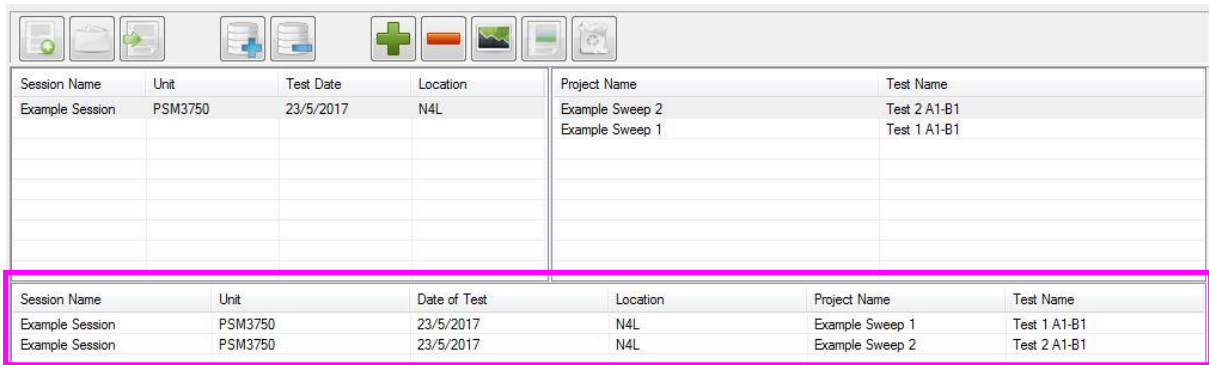

Session Name	Unit	Test Date	Location	Project Name	Test Name
Example Session	PSM3750	23/5/2017	N4L	Example Sweep 2	Test 2 A1-B1
				Example Sweep 1	Test 1 A1-B1

Session Name	Unit	Date of Test	Location	Project Name	Test Name
Example Session	PSM3750	23/5/2017	N4L	Example Sweep 1	Test 1 A1-B1
Example Session	PSM3750	23/5/2017	N4L	Example Sweep 2	Test 2 A1-B1

Once all the tests to be exported have been selected, press the **Export Selected Tests** button:

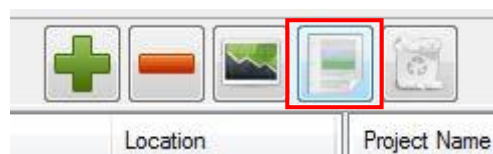

The Export Tests Window appears. Select **CSV format** and then press **OK**

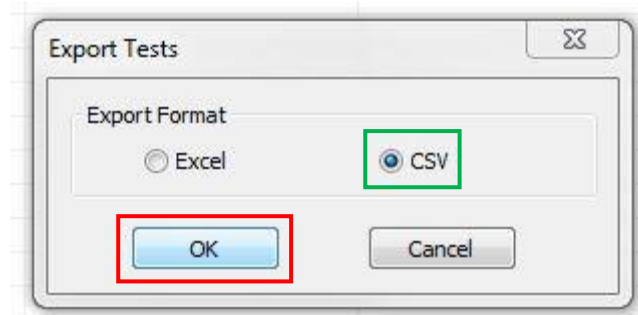

PSMComm2 will then ask for a folder to place the exported tests into, navigate to the place where the CSV files are to be saved and press **OK**:

PSMComm2 Software User Manual

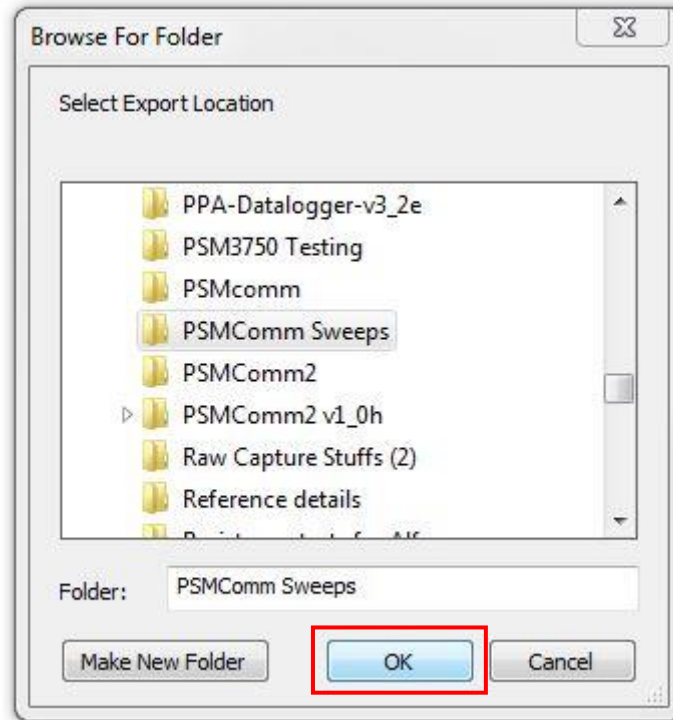

The exported CSV files will be placed in the selected folder and will be named the same as the Test Name field entered when running the sweep.

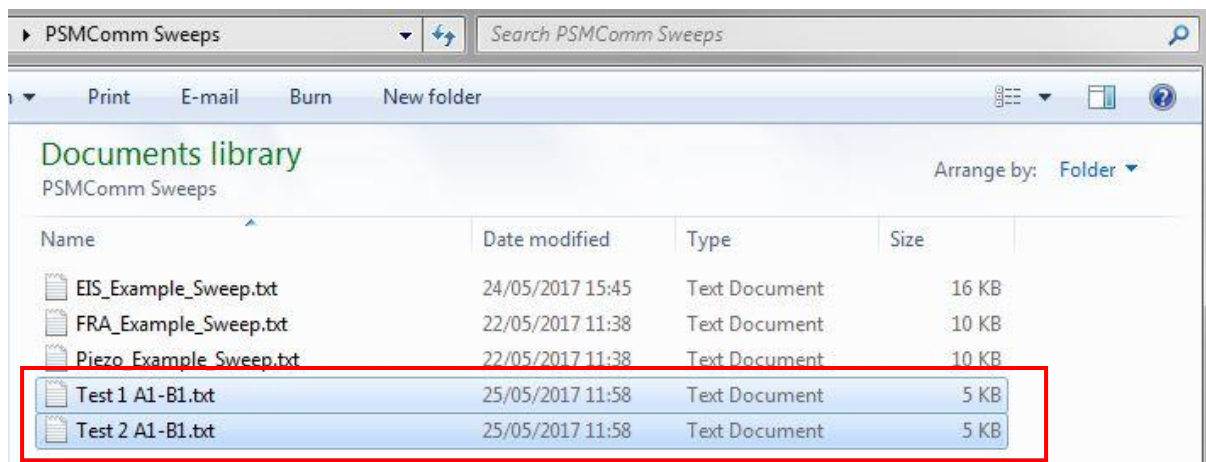

10.6 Exporting a Database Test to Excel

To export tests from the PSMComm2 Database to Excel, first select the tests to be exported. This can be done by clicking on the test to be exported and pressing the **Add Test to Selection** button:

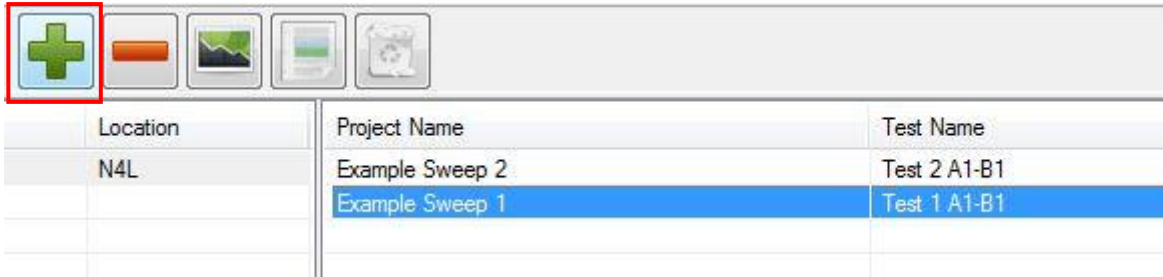

Multiple tests can be exported so this process should be repeated until all required tests have been selected. Alternatively, double-clicking on the test will select it.

The selected tests will then appear in the lower part of the Database window, the **Selection Window**.

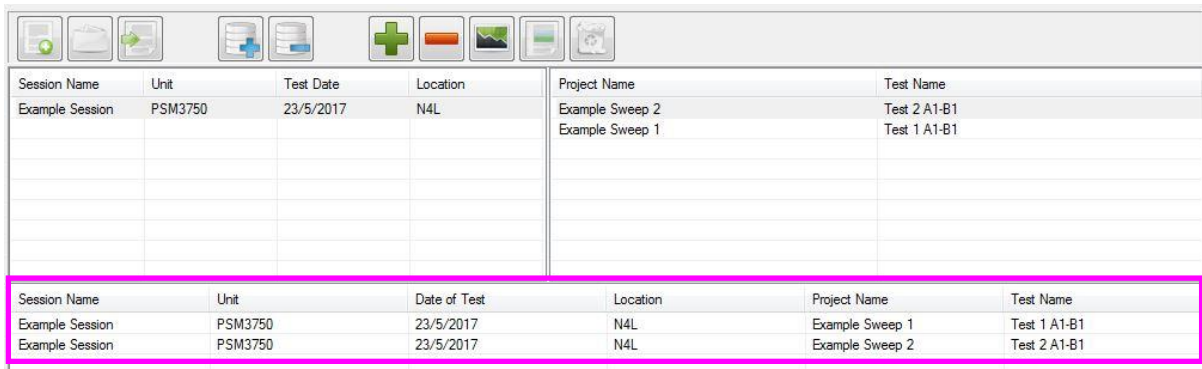

Once all the tests to be exported have been selected, press the **Export Selected Tests** button:



The Export Tests Window appears. Select **Excel format** and then press **OK**

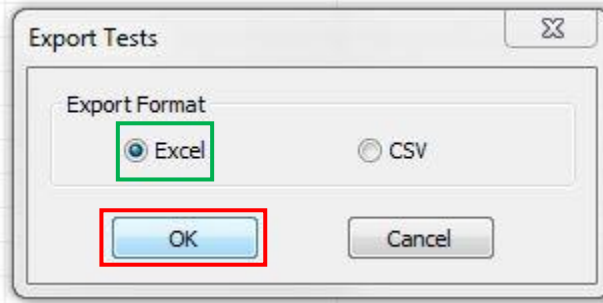

PSMComm2 will then export each of the tests into a single excel document, with the tests placed side by side to each other.

PSMComm2 v1_1c					PSMComm2 v1_1c				
Test 1 A1-B1					Test 2 A1-B1				
Step	Frequency	Gain	Phase		Step	Frequency	Gain	Phase	
1	1.00E+03	-2.43E+01	-9.41E+01		1	1.00E+03	-2.43E+01	-9.41E+01	
2	1.07E+03	-2.37E+01	-9.44E+01		2	1.07E+03	-2.37E+01	-9.44E+01	
3	1.15E+03	-2.31E+01	-9.46E+01		3	1.15E+03	-2.31E+01	-9.46E+01	
4	1.23E+03	-2.25E+01	-9.49E+01		4	1.23E+03	-2.25E+01	-9.49E+01	
5	1.32E+03	-2.19E+01	-9.52E+01		5	1.32E+03	-2.19E+01	-9.52E+01	
6	1.42E+03	-2.13E+01	-9.55E+01		6	1.42E+03	-2.13E+01	-9.55E+01	
7	1.52E+03	-2.07E+01	-9.59E+01		7	1.52E+03	-2.07E+01	-9.59E+01	
8	1.63E+03	-2.01E+01	-9.63E+01		8	1.63E+03	-2.01E+01	-9.63E+01	
9	1.75E+03	-1.96E+01	-9.67E+01		9	1.75E+03	-1.96E+01	-9.67E+01	
10	1.87E+03	-1.90E+01	-9.71E+01		10	1.87E+03	-1.90E+01	-9.71E+01	
11	2.01E+03	-1.84E+01	-9.76E+01		11	2.01E+03	-1.84E+01	-9.76E+01	
12	2.15E+03	-1.78E+01	-9.81E+01		12	2.15E+03	-1.78E+01	-9.81E+01	
13	2.31E+03	-1.72E+01	-9.86E+01		13	2.31E+03	-1.72E+01	-9.86E+01	
14	2.48E+03	-1.66E+01	-9.91E+01		14	2.48E+03	-1.66E+01	-9.91E+01	
15	2.66E+03	-1.60E+01	-9.97E+01		15	2.66E+03	-1.60E+01	-9.97E+01	
16	2.85E+03	-1.54E+01	-1.00E+02		16	2.85E+03	-1.54E+01	-1.00E+02	
17	3.05E+03	-1.48E+01	-1.01E+02		17	3.05E+03	-1.48E+01	-1.01E+02	

10.7 Graphing a Database Test

The Sweeps stored in the database can be viewed graphically using the **Graph Selected Tests** button. This can be done by clicking on the test to be exported and pressing the **Add Test to Selection** button:



10.8 Database Graph Settings

The Database Graph can be customized by using the menu options in the top corner of the Graph Window.

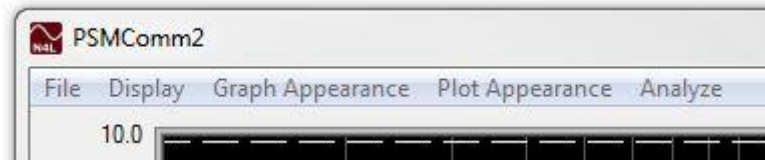

The Graph Appearance and Plot Appearance options feature drop-down menus that allow various settings to be adjusted:

Graph Appearance > Graph Scaling

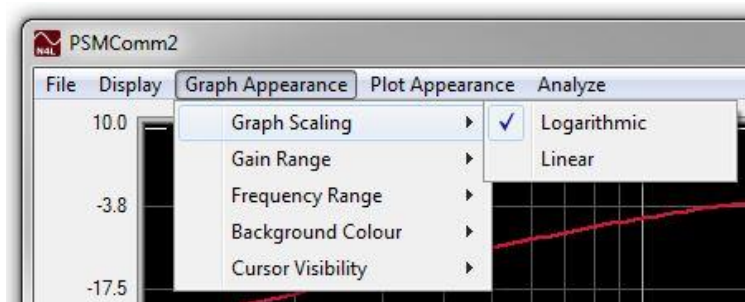

The X-axis scaling can be set to Linear or Logarithmic.

Graph Appearance > Gain Range

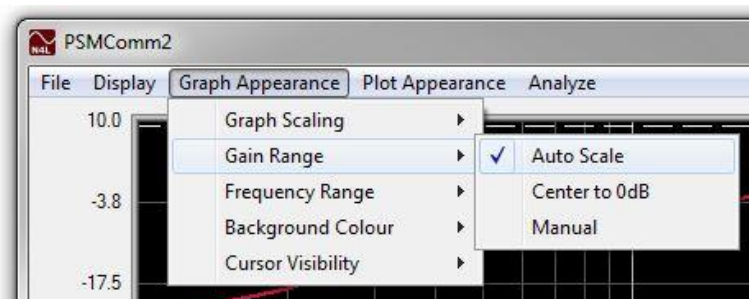

The Gain range defaults to Auto Scale; this can be changed to Centred to 0dB or manual ranging.

Graph Appearance > Frequency Range

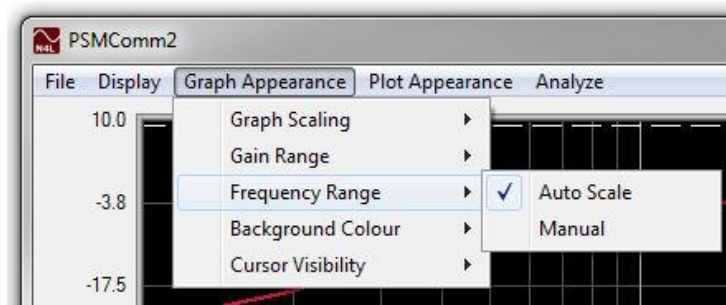

The Frequency ranging defaults to auto scale but can be changed to manual ranging.

Graph Appearance > Background Colour

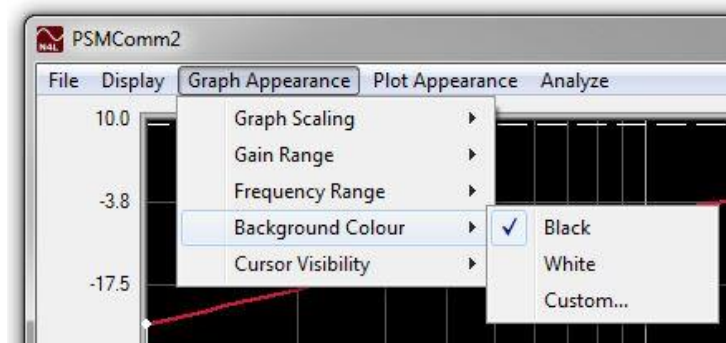

The default graph background is black but can be changed to White or customised to any colour.

Graph Appearance > Cursor Visibility

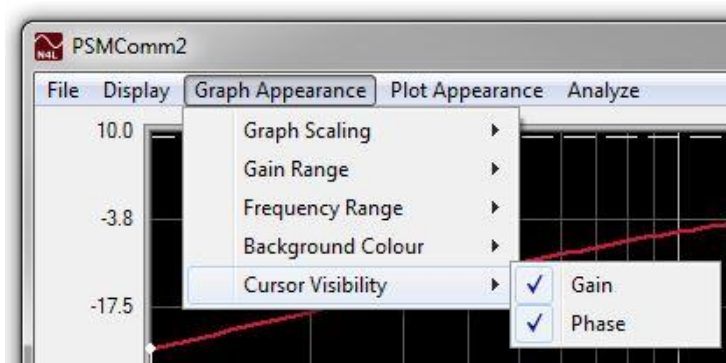

The cursors can be displayed or hidden for the Gain and Phase responses.

PSMComm2 Software User Manual

The Plot Appearance menu allows each individual plot to be customised.

Plot Appearance > Test Name > Visible >

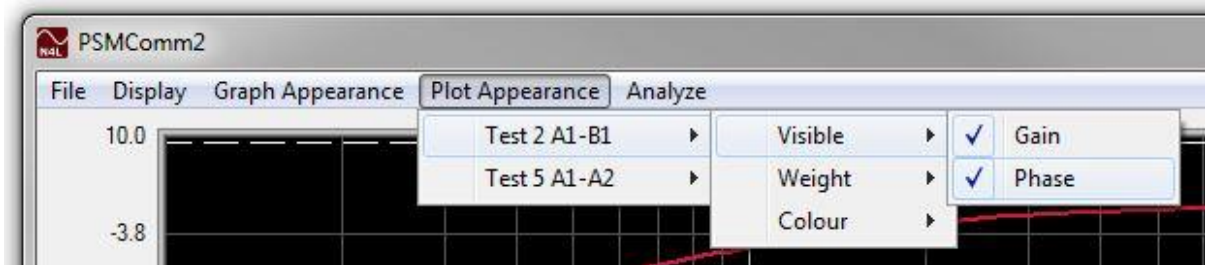

For each test, the user can choose whether or not to display the Gain or Phase plots.

Plot Appearance > Test Name > Weight > Gain / Phase >

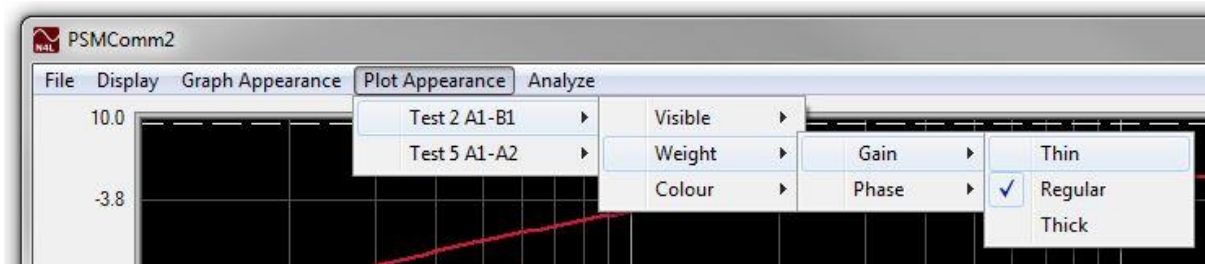

The thickness of each individual Gain and Phase plotline can be adjusted for each test included on the graph. Default is regular but this can be changed to Thin or Thick. The selections are also independent of each other.

Plot Appearance > Test Name > Gain Phase Margins > Visibility

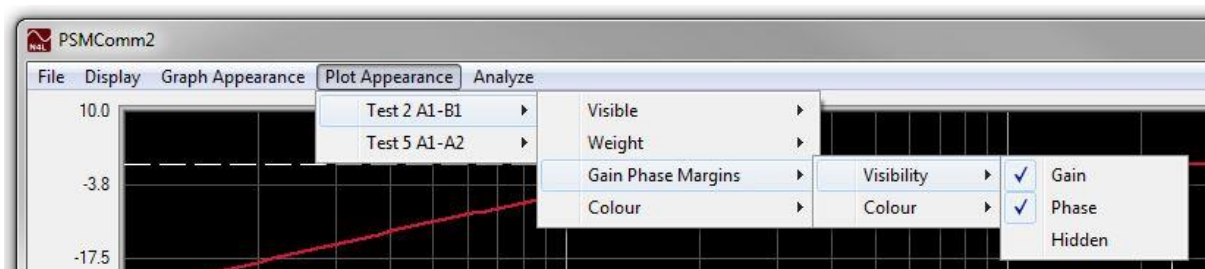

The user can choose whether or not to display the Gain and/or Phase margins along with the suboptimal gain/phase points.

PSMComm2 Software User Manual

Plot Appearance > Test Name > Gain Phase Margins > Colour

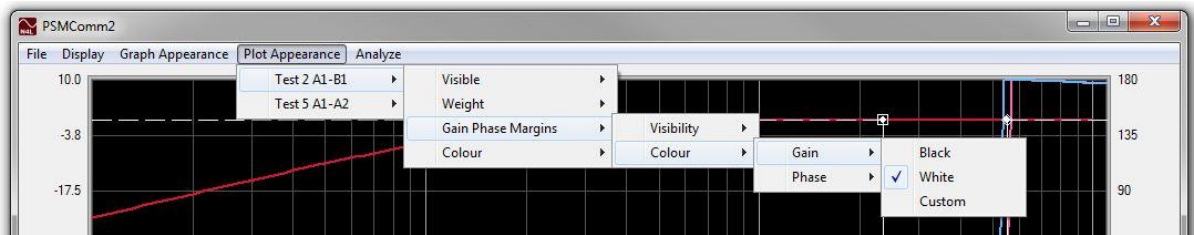

The default colour of each of the individual Gain and Phase margins is white; this can be adjusted to black or customised to any colour by the user.

Plot Appearance > Test Name > Colour > Gain / Phase >

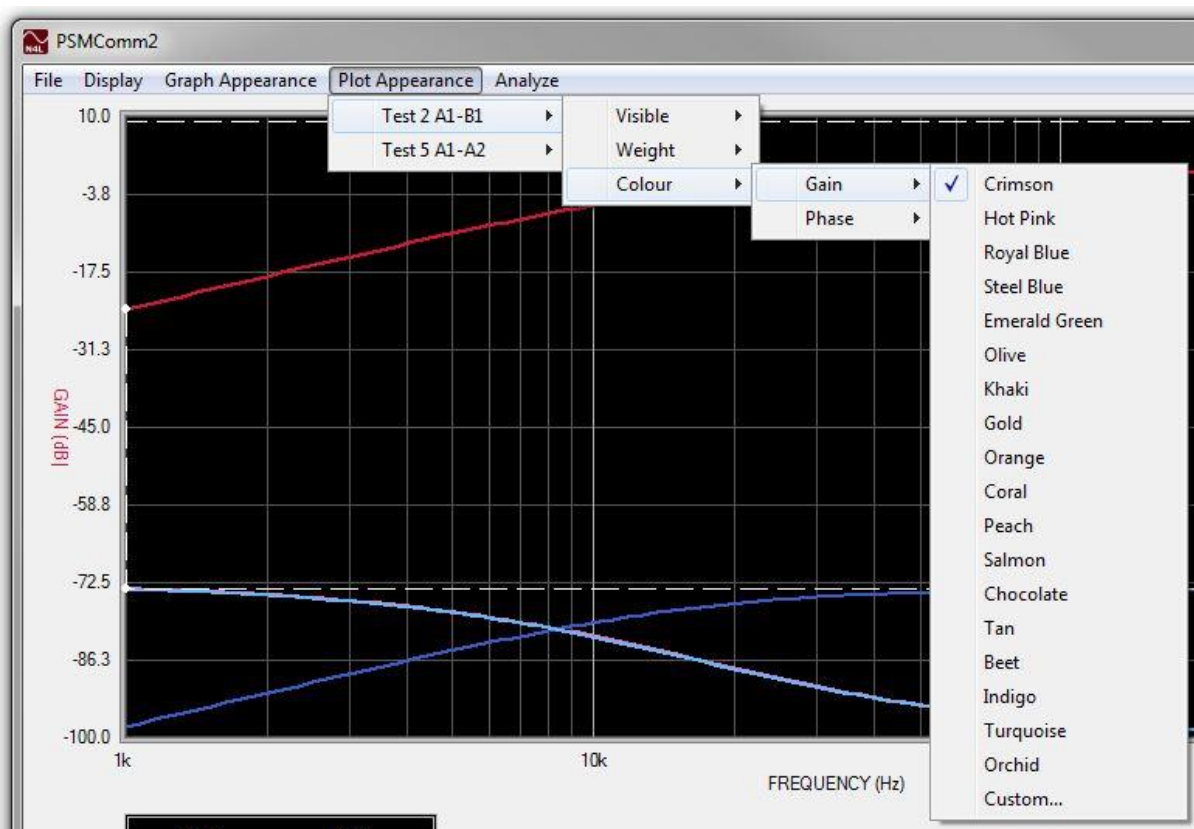

The colour of each individual Gain and Phase plot can be selected from the list of colours on the drop-down menu.

10.9 Finding the Gain/Phase Margins

To get PSMComm2's Database graph to find and display the Gain/Phase margins, go to **Analyze** and select Find Gain/Phase Margins from the drop-down menu.

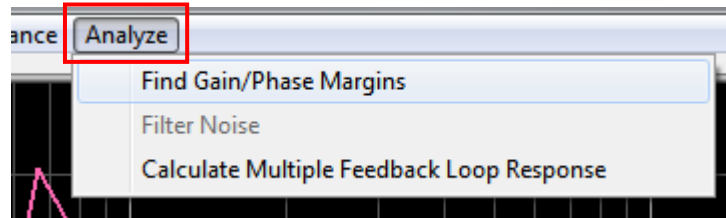

PSMComm2 will then find all the Gain/Phase points on each of the plots in the graph, and display the best pair for each plot. The gain crossover points are represented with a square, the phase crossover points are represented with a rhomboid.

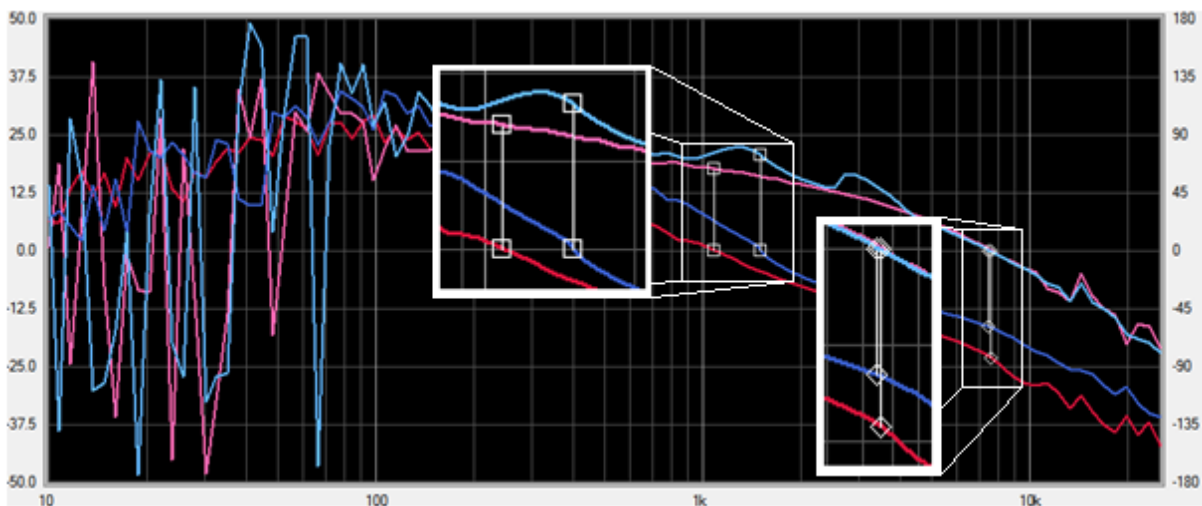

The cursors are placed in the optimal gain/phase points for the currently selected plot.

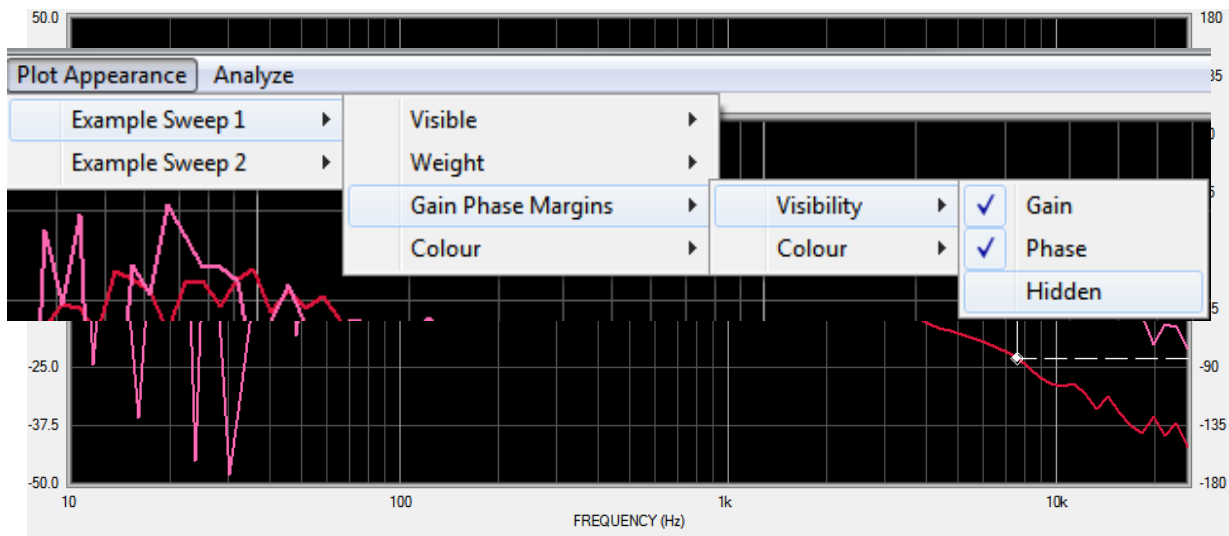

All the gain/phase points can be drawn by making the "hidden" gain/phase margin points visible in the Plot Appearance menu.

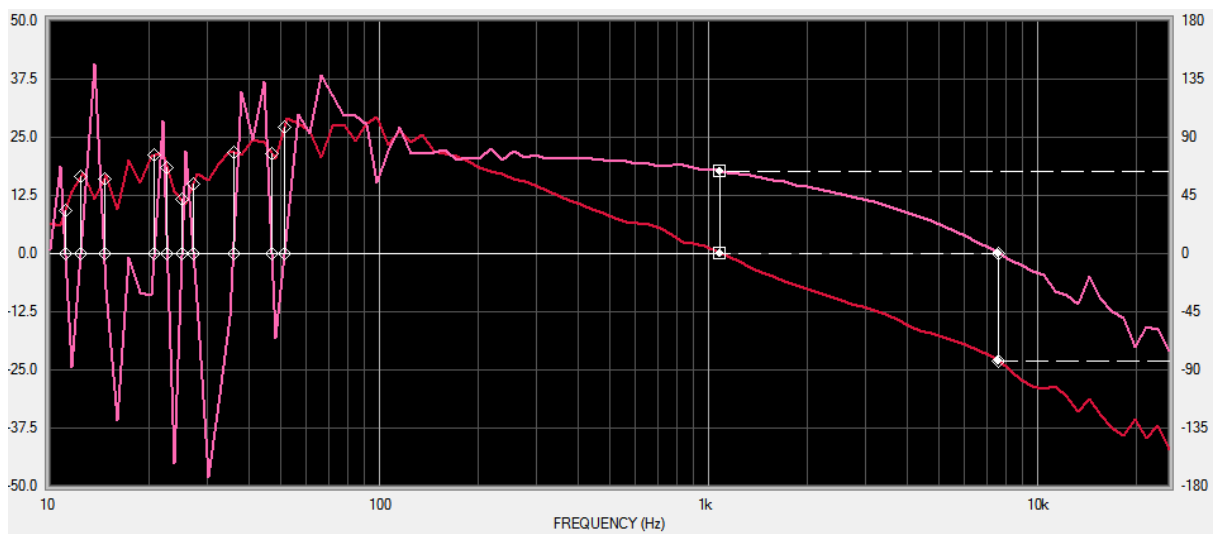

10.10 Calculating Multiple Feedback Loop Response

PSMComm2 can calculate the feedback loop response from 2 or 3 loops. With 2 or more plots selected to graph from the database, go to the Analyze menu on PSMComm2's database graph and select "Calculate Multiple Feedback Loop Response":

PSMComm2 Software User Manual

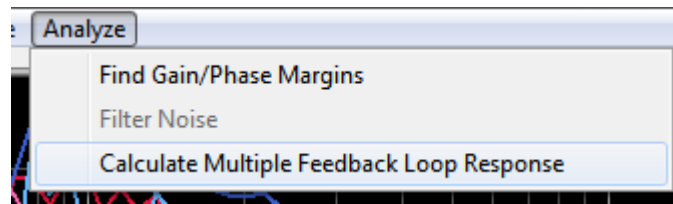

This will bring up the Loop selection window which asks you which of the plots should be used for the calculation:

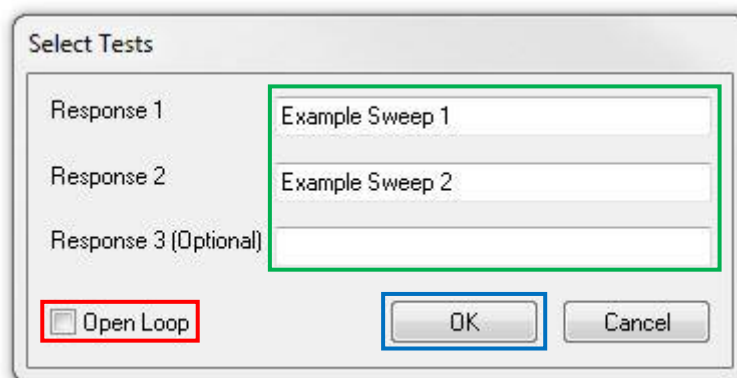

To change which plots will be used, click in the **text boxes** beside "Response 1", "Response 2" and the optional "Response 3" and this window will appear showing you which plots you have to choose from:

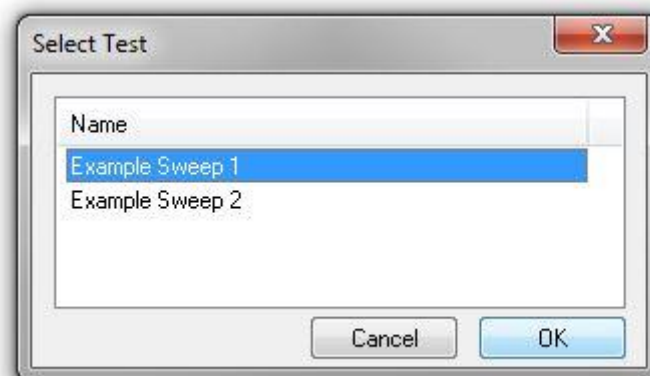

Select the plot you want to use and press "OK" to confirm.

PSMComm2 Software User Manual

Once the correct plots have been selected, you can have the calculation performed as if it were an open loop by ticking the **Open Loop** tick box.

When all the settings are correct, press **OK** to have PSMComm2 calculate the Multiple Feedback Loop Response.

There will be 2 new dashed lines on the graph, these are the gain and phase for the calculated response.

This is a graph of the gain of the two selected plots and the calculated response:

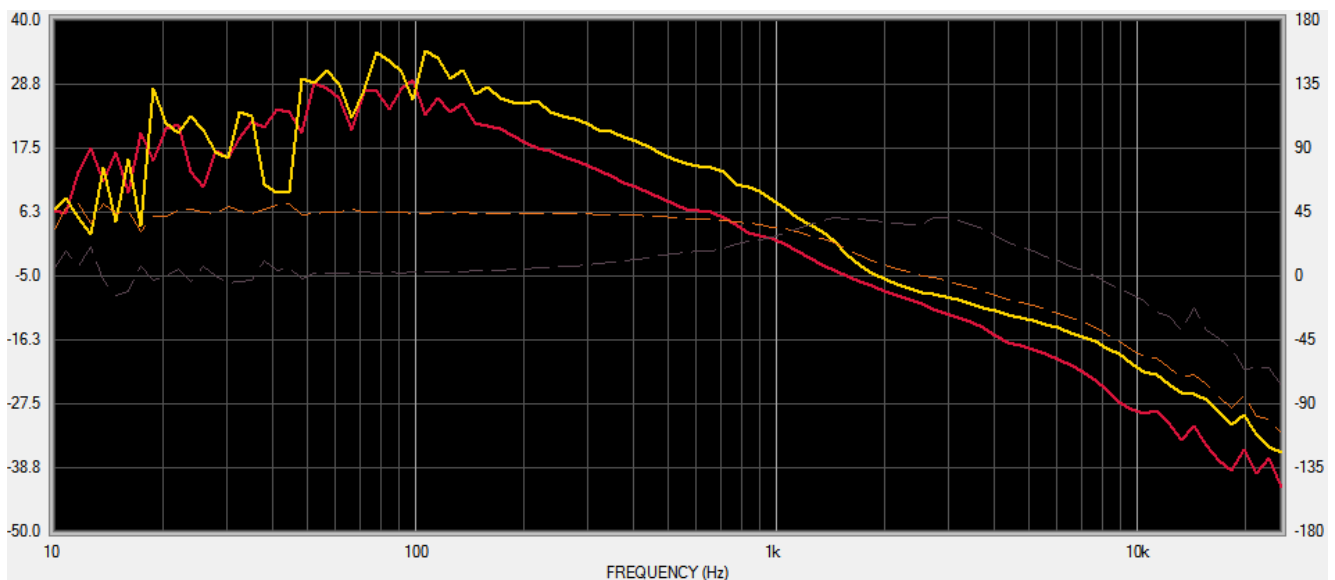

And the phase of the two selected plots and the calculated response:

PSMComm2 Software User Manual

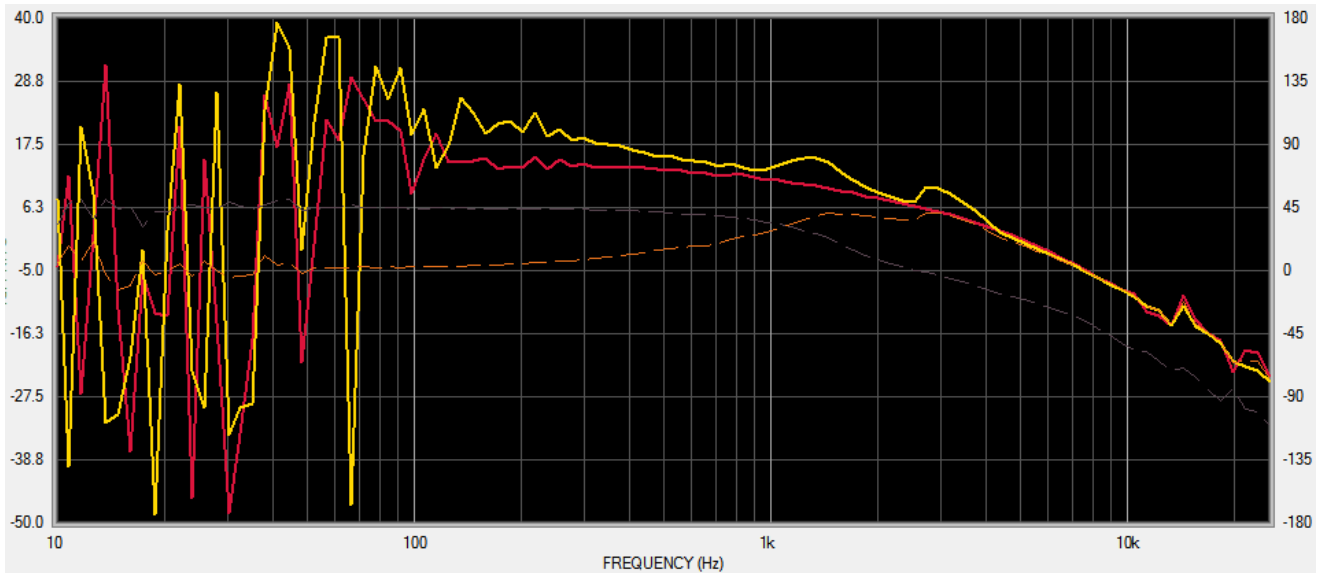

11 Capture Mode

11.1 Downloading a screenshot from a PSM.

To switch PSMComm2 to Capture Mode, press the **Capture** menu item at the top of PSMComm2.



This puts PSMComm2 into Capture Mode.

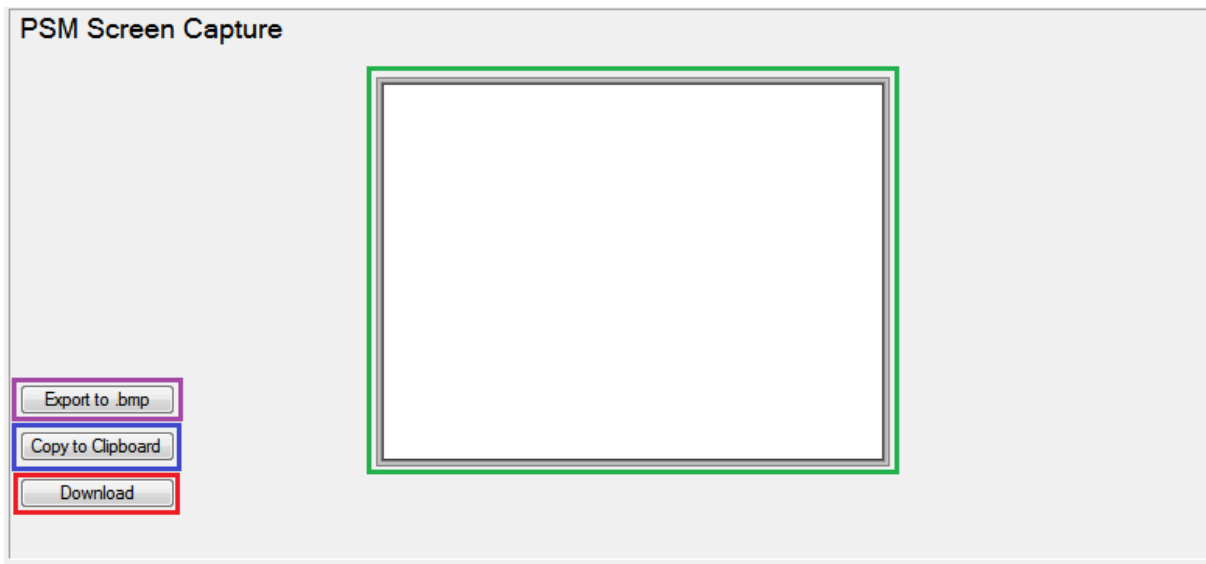

To download a screenshot from the PSM display screen, press the **Download** button.

PSMComm2 will show the download within a Progress Window

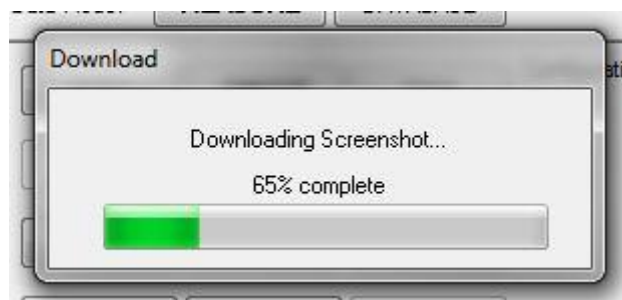

PSMComm2 Software User Manual

Once the download is complete, the screenshot from the PSM will be placed on the **Canvas**.

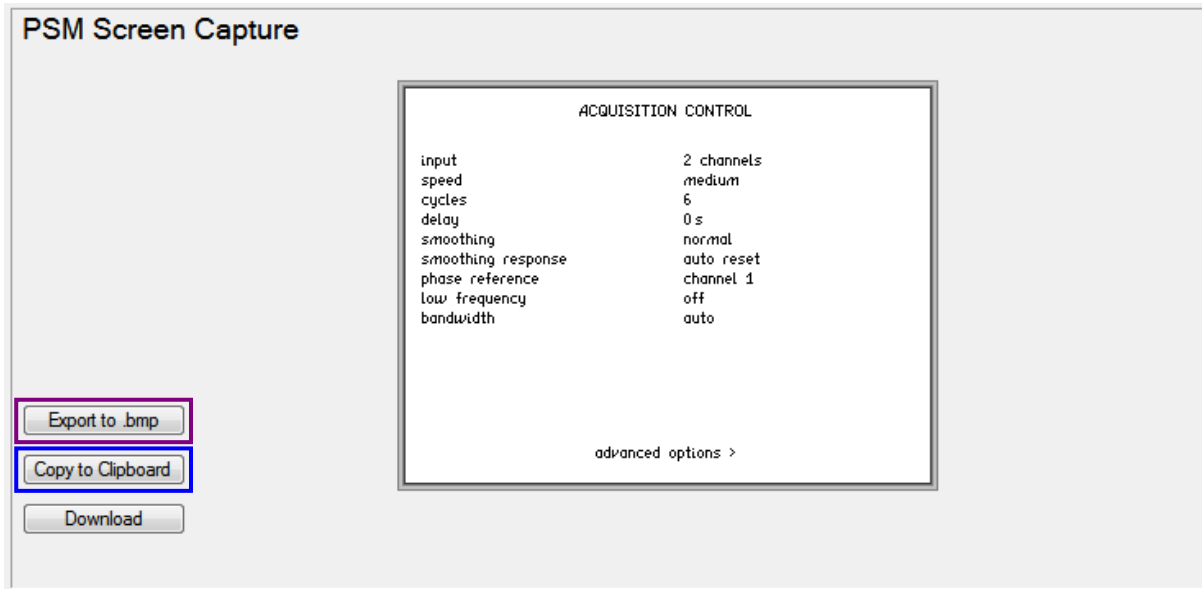

Now the screenshot can be copied to Clipboard for pasting into emails, image editors or anywhere else using **Copy to Clipboard**, and Saved as a bitmap image using **Export to Bitmap**.

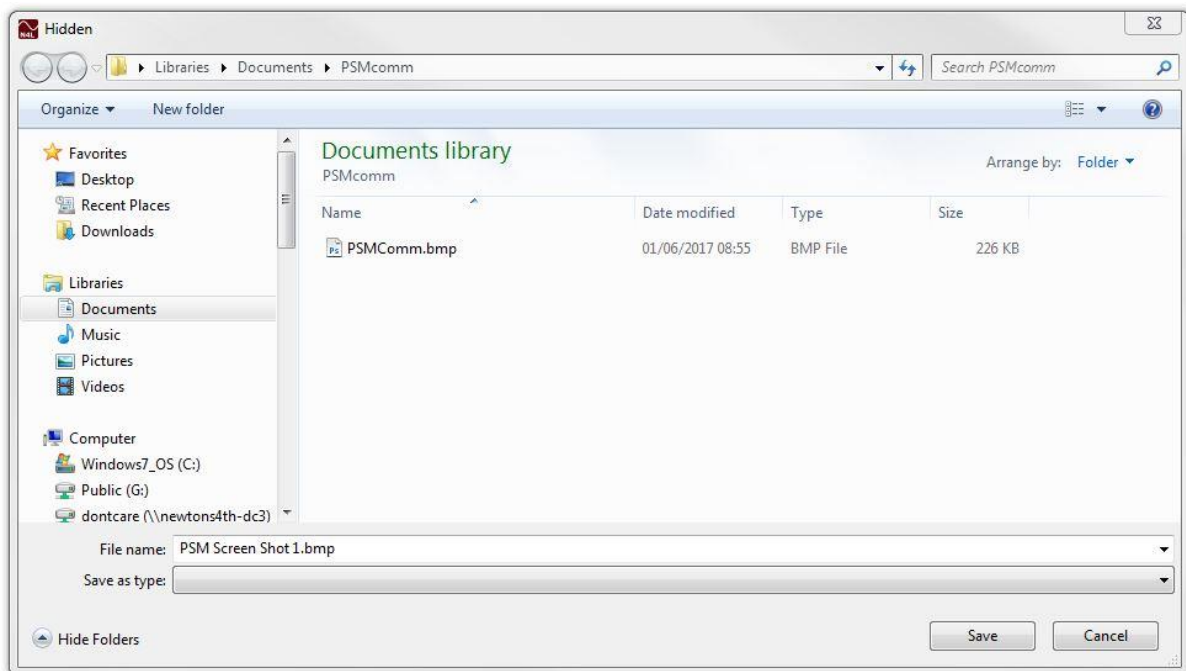

12 Using PSMComm2 CSV Files

12.1 Importing CSV Files into Excel

CSV Files exported from any mode in PSMComm2 can be loaded into Excel as data, creating a spreadsheet from the CSV.

To load the data into Excel, open Excel and select the first cell to enter the data into

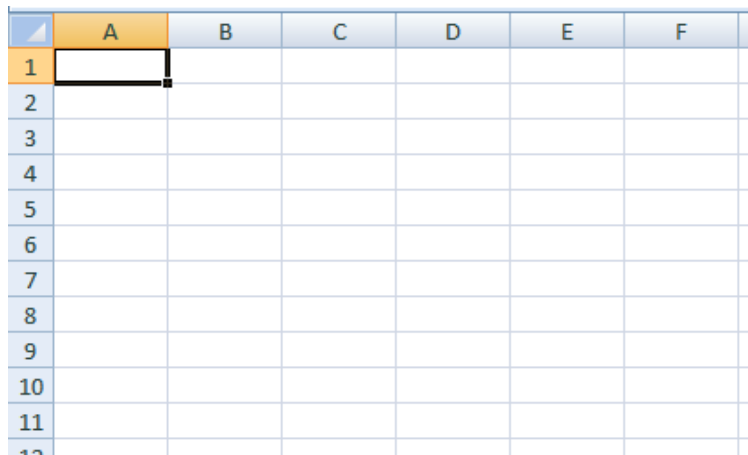

Then go to the **Data Tab** and click the **From Text** button.

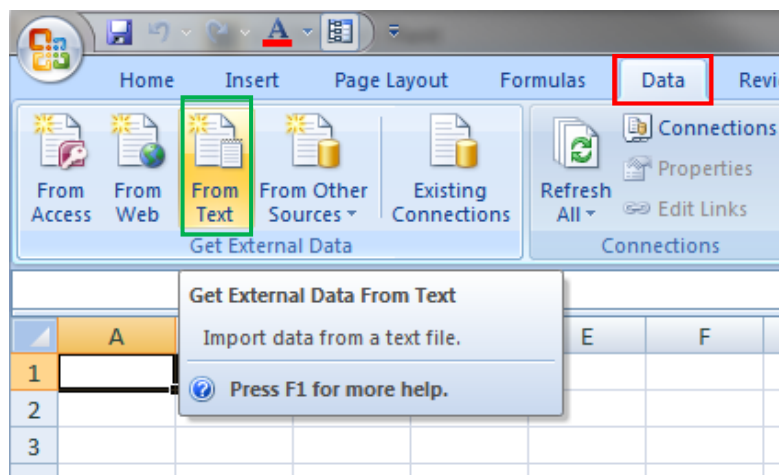

After navigating to and selecting the file to be loaded into Excel, press the **Import** button.

PSMComm2 Software User Manual

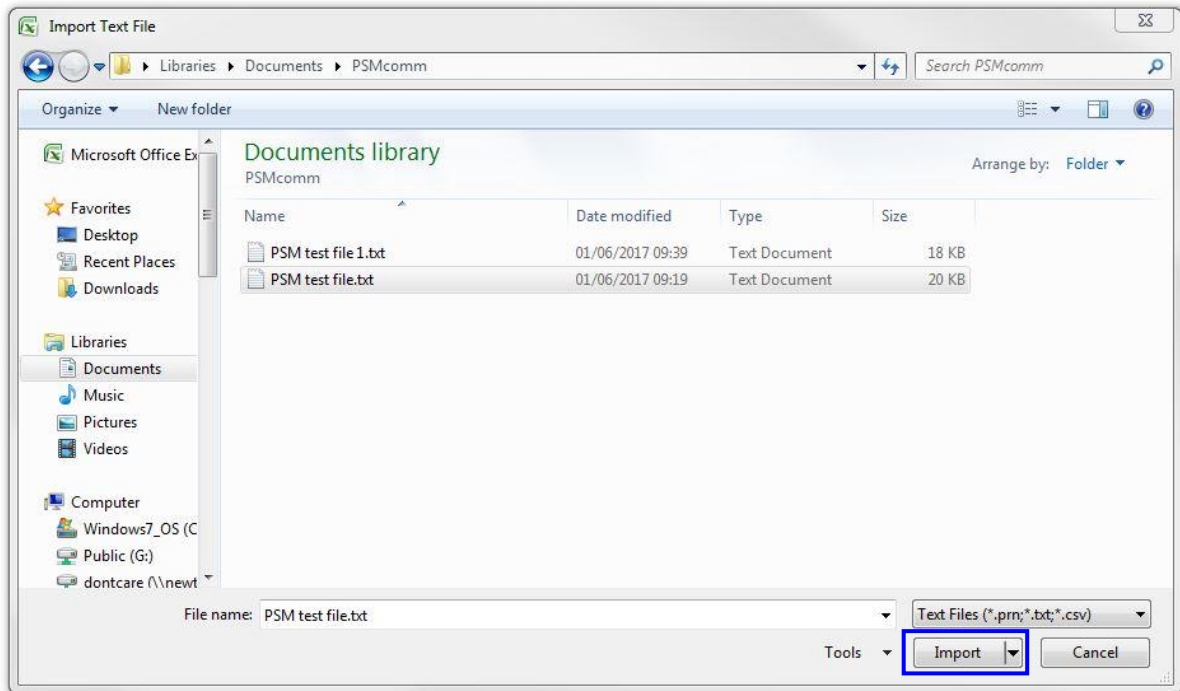

Excel will then ask if the data should be imported as a Delimited file or Fixed Width. Ensure **Delimited** is selected and press **Next**.

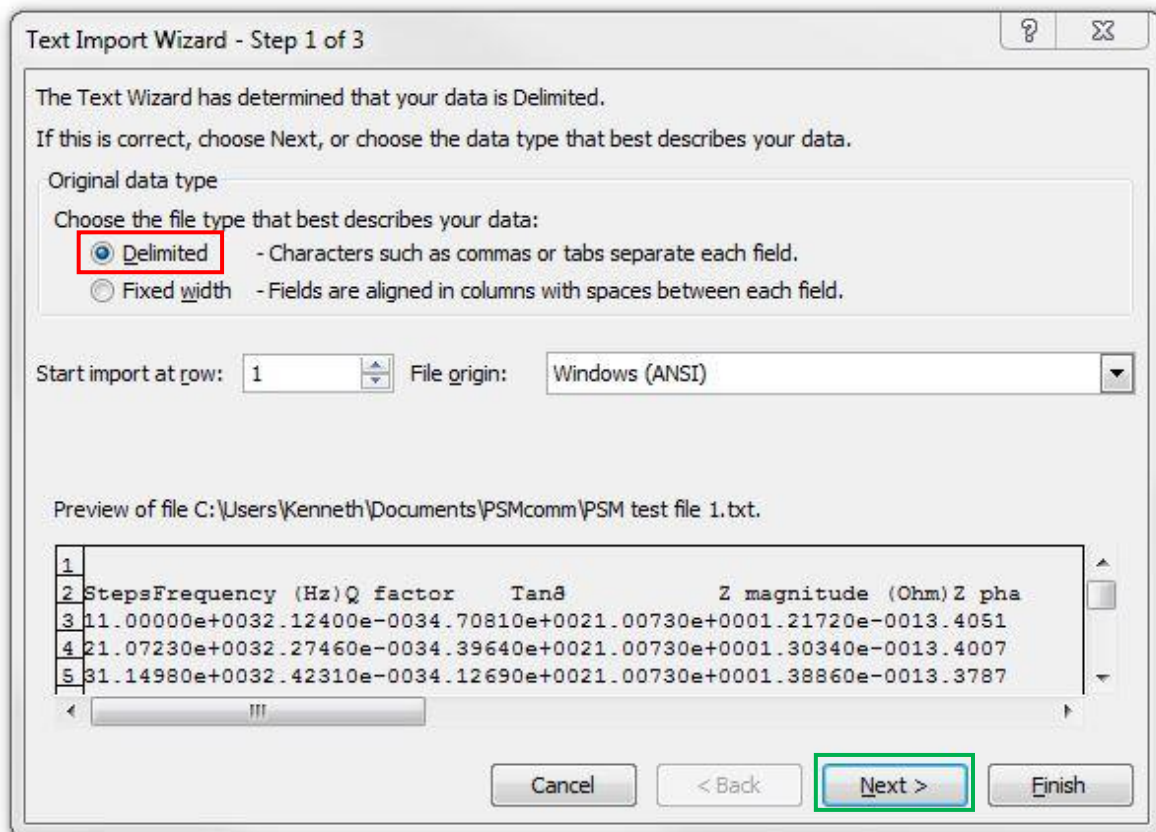

Excel will then ask what the data in the file is delimited by. Ensure that **Tab** is selected and press **Next**.

PSMComm2 Software User Manual

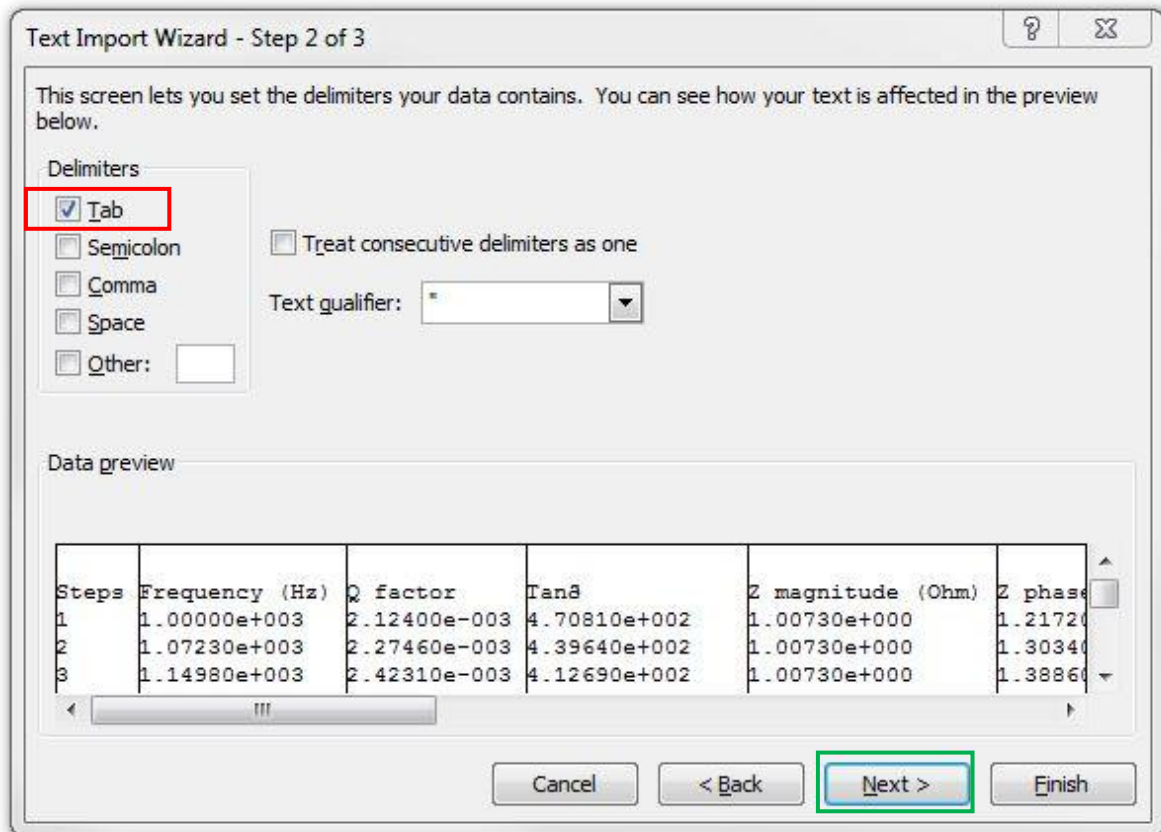

Finally, if you set a custom locale, go to [Advanced](#), and tell Excel what it should use as Decimal and Thousand separators.

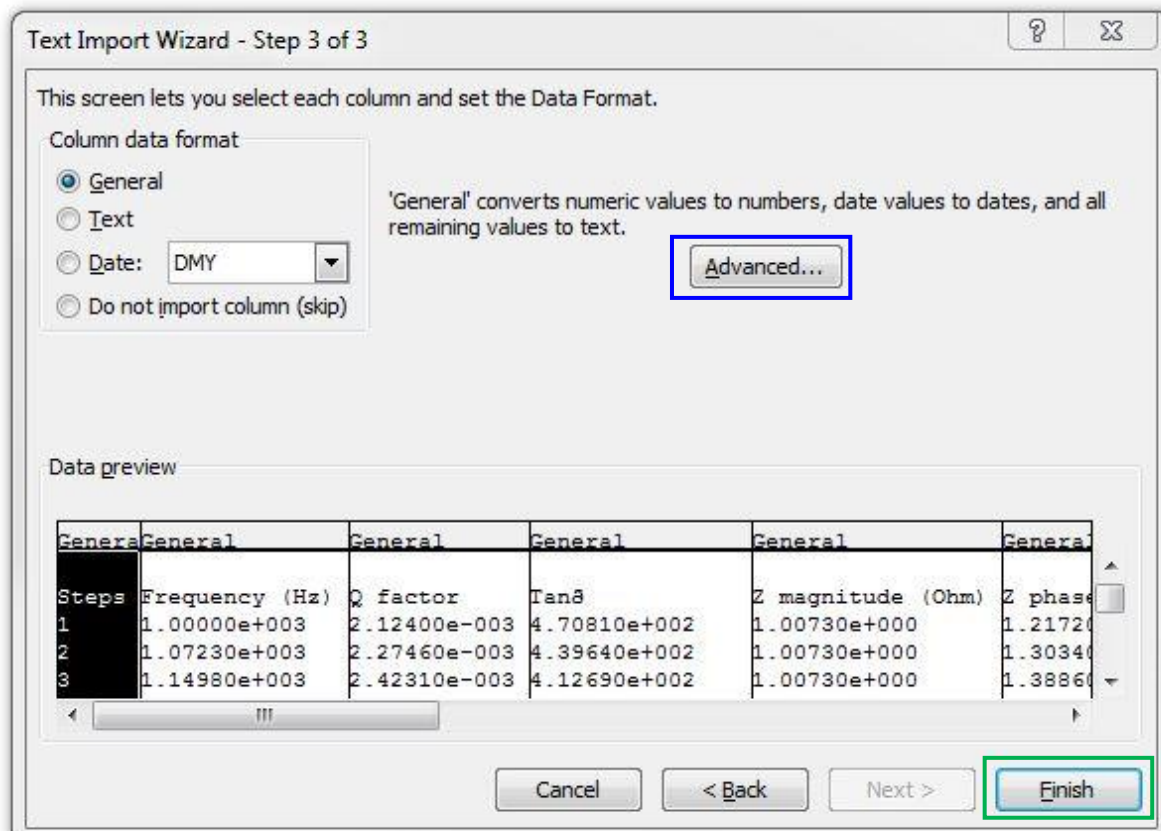

Select the required separators from the drop-down menus. Then press **OK** to return to the Text import wizard step 3.

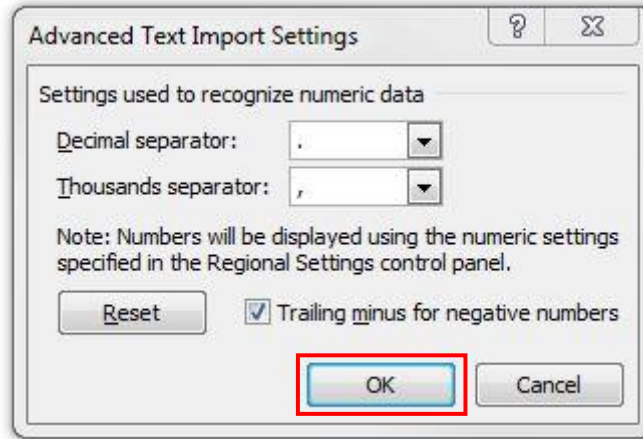

Press the **Finish** button then press **OK** on the next window, or set a new location for the data to be imported to.

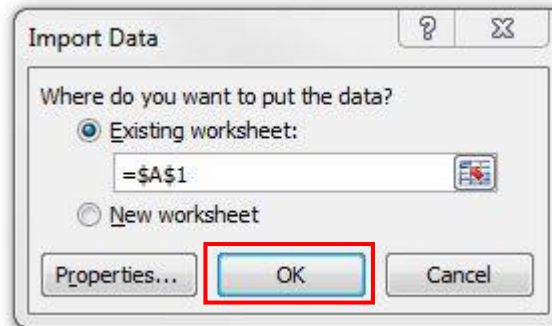

Excel will place the CSV into the spreadsheet separated by column.

	A	B	C	D	E	F	G	H	I	J	K	L	M	N	O
1															
2	Steps	Frequency (Hz)	Q factor	Tanδ	Z magnitude (Ohm)	Z phase (°)	Series L (H)	Series C (F)	Series R (Ohm)	Y magnitude (Ohm)	Y phase (°)	Parallel L (H)	Parallel C (F)	Parallel R (Ohm)	
3	1	1.00E+03	2.12E-03	4.71E+02	1.01E+00	1.22E-01	3.41E-07	-7.44E-02	1.01E+00	9.93E-01	-1.22E-01	7.55E-02	-3.36E-07	1.01E+00	
4	2	1.07E+03	2.27E-03	4.40E+02	1.01E+00	1.30E-01	3.40E-07	-6.48E-02	1.01E+00	9.93E-01	-1.30E-01	6.57E-02	-3.35E-07	1.01E+00	
5	3	1.15E+03	2.42E-03	4.13E+02	1.01E+00	1.39E-01	3.38E-07	-5.67E-02	1.01E+00	9.93E-01	-1.39E-01	5.75E-02	-3.33E-07	1.01E+00	
6	4	1.23E+03	2.62E-03	3.81E+02	1.01E+00	1.50E-01	3.41E-07	-4.88E-02	1.01E+00	9.93E-01	-1.50E-01	4.95E-02	-3.36E-07	1.01E+00	
7	5	1.32E+03	2.85E-03	3.50E+02	1.01E+00	1.64E-01	3.46E-07	-4.19E-02	1.01E+00	9.93E-01	-1.64E-01	4.25E-02	-3.41E-07	1.01E+00	
8	6	1.42E+03	3.05E-03	3.28E+02	1.01E+00	1.75E-01	3.45E-07	-3.65E-02	1.01E+00	9.93E-01	-1.75E-01	3.71E-02	-3.40E-07	1.01E+00	
9	7	1.52E+03	3.24E-03	3.09E+02	1.01E+00	1.85E-01	3.41E-07	-3.21E-02	1.01E+00	9.93E-01	-1.85E-01	3.26E-02	-3.36E-07	1.01E+00	
10	8	1.63E+03	3.50E-03	2.86E+02	1.01E+00	2.00E-01	3.44E-07	-2.77E-02	1.01E+00	9.93E-01	-2.00E-01	2.81E-02	-3.39E-07	1.01E+00	
11	9	1.75E+03	3.78E-03	2.64E+02	1.01E+00	2.17E-01	3.47E-07	-2.39E-02	1.01E+00	9.93E-01	-2.17E-01	2.43E-02	-3.42E-07	1.01E+00	
12	10	1.87E+03	3.98E-03	2.51E+02	1.01E+00	2.28E-01	3.41E-07	-2.12E-02	1.01E+00	9.93E-01	-2.28E-01	2.15E-02	-3.36E-07	1.01E+00	
13	11	2.01E+03	4.29E-03	2.33E+02	1.01E+00	2.46E-01	3.42E-07	-1.83E-02	1.01E+00	9.93E-01	-2.46E-01	1.86E-02	-3.37E-07	1.01E+00	
14	12	2.15E+03	4.54E-03	2.20E+02	1.01E+00	2.60E-01	3.38E-07	-1.61E-02	1.01E+00	9.93E-01	-2.60E-01	1.64E-02	-3.33E-07	1.01E+00	
15	13	2.31E+03	4.90E-03	2.04E+02	1.01E+00	2.81E-01	3.40E-07	-1.40E-02	1.01E+00	9.93E-01	-2.81E-01	1.42E-02	-3.35E-07	1.01E+00	
16	14	2.48E+03	5.26E-03	1.90E+02	1.01E+00	3.02E-01	3.41E-07	-1.21E-02	1.01E+00	9.92E-01	-3.02E-01	1.23E-02	-3.36E-07	1.01E+00	
17	15	2.66E+03	5.68E-03	1.76E+02	1.01E+00	3.25E-01	3.43E-07	-1.05E-02	1.01E+00	9.92E-01	-3.25E-01	1.06E-02	-3.38E-07	1.01E+00	
18	16	2.85E+03	6.02E-03	1.66E+02	1.01E+00	3.45E-01	3.39E-07	-9.21E-03	1.01E+00	9.92E-01	-3.45E-01	9.35E-03	-3.34E-07	1.01E+00	
19	17	3.05E+03	6.52E-03	1.53E+02	1.01E+00	3.74E-01	3.42E-07	-7.93E-03	1.01E+00	9.92E-01	-3.74E-01	8.06E-03	-3.37E-07	1.01E+00	
20	18	3.27E+03	6.96E-03	1.44E+02	1.01E+00	3.99E-01	3.41E-07	-6.93E-03	1.01E+00	9.92E-01	-3.99E-01	7.03E-03	-3.36E-07	1.01E+00	
21	19	3.51E+03	7.44E-03	1.34E+02	1.01E+00	4.27E-01	3.40E-07	-6.04E-03	1.01E+00	9.92E-01	-4.27E-01	6.14E-03	-3.35E-07	1.01E+00	
22	20	3.77E+03	8.01E-03	1.25E+02	1.01E+00	4.59E-01	3.41E-07	-5.23E-03	1.01E+00	9.92E-01	-4.59E-01	5.32E-03	-3.36E-07	1.01E+00	
23	21	4.04E+03	8.50E-03	1.18E+02	1.01E+00	4.87E-01	3.38E-07	-4.60E-03	1.01E+00	9.92E-01	-4.87E-01	4.67E-03	-3.33E-07	1.01E+00	
24	22	4.33E+03	9.23E-03	1.08E+02	1.01E+00	5.29E-01	3.42E-07	-3.95E-03	1.01E+00	9.92E-01	-5.29E-01	4.02E-03	-3.37E-07	1.01E+00	
25	23	4.64E+03	9.84E-03	1.02E+02	1.01E+00	5.64E-01	3.40E-07	-3.46E-03	1.01E+00	9.92E-01	-5.64E-01	3.51E-03	-3.35E-07	1.01E+00	

Contact Details

If you require any further assistance with the operation of PSMComm2 please do not hesitate to contact your local distributor or N4L:

Newtons4th Ltd.
1 Bede Island Road
Leicester
LE2 7EA
United Kingdom

E-mail address support@newtons4th.com

Tel: (0116) 230 1066 international +44 116 230 1066

Fax: (0116) 230 1061 international +44 116 230 1061

Website: www.newtons4th.com